



ABC GREENHOUSE STYLE BODY

*TWO-PIECE ROOF CONFIGURATION ALLOWS FOR
PRECISION FIT & ADDED DURABILITY*

The two-piece roof configuration features mounting flanges with built-in locating tabs to speed up installation. This body comes standard with high-impact plastic quarter panels that are durable & easier to replace.





- » Streamlined greenhouse body design for simplified installation, reducing time and cost associated with quarter panel replacement compared to traditional styles
- » Designed to fit templates perfectly
- » Consistent & repeatable fit for all replacement panels
- » Rear window installation made easy and hassle-free
- » Common body has 4 different options
- » Available in 4 colors



ABC GREENHOUSE STYLE

BODY PANELS & OPTIONS

HOW TO ORDER YOUR BODY IN 3 QUICK & EASY STEPS

» 1. SELECT BODY PACKAGE » 2. SELECT PANEL COLOR » 3. SELECT NOSE MAKE

RE-SKIN BODY PACKAGE

| | | -W | -B | -CB | -R |
|--|------------------|----------------|----|----------------|----|
| Bumper Cover, Rear, high-impact plastic | 460-450-x | \$155 | | \$160 | |
| Door, aluminum, left | 661-21A-xL | \$112 | | \$112 | |
| Door, aluminum, right | 661-21A-xR | \$112 | | \$112 | |
| Fender, 10" tires, high-impact plastic, left | 660-24-xL | \$150 | | \$154 | |
| Fender, 10" tires, high-impact plastic, right | 660-24-xR | \$150 | | \$154 | |
| Nose, high-impact plastic (SPECIFY MAKE: CHEVY SS-660; FUSION-570; CAMRY-720; CHARGER-470 IS B/W ONLY) | xxx-410-x | \$164 | | \$171 | |
| Quarter Panel, high-impact plastic, left | 670-27-xL | \$134 | | \$142 | |
| Quarter Panel, high-impact plastic, right | 670-27-xR | \$134 | | \$142 | |
| Rocker Panel, fits either side, high-impact plastic (2 REQUIRED) SPECIFY COLOR: -W -B -CB -R -Y | 000-5501P-x | \$33 | | \$38 | |
| Rocker Panel, fits either side, high-impact plastic (ENTERED TWICE TO SHOW PACKAGE PRICE) | 000-5501P-x | \$33 | | \$38 | |
| RE-SKIN BODY PACKAGE PRICE | 593-100-x | \$1,177 | | \$1,223 | |

COMPLETE BODY PACKAGE (RE-SKIN COMPONENTS PLUS ITEMS BELOW)

| | | | | | |
|--|------------------|----------------|--|----------------|--|
| Cowl Panel Kit (INCLUDES COWL AIR INSERT AND TABS), ULTRAGLASS COMPOSITE WITH FIRE RETARDANT RESIN | 671-5100-x | \$249 | | \$299 | |
| Deck Lid Hold-Down Strip, aluminum | XM 000-310H-x | \$10 | | \$10 | |
| Deck Lid, aluminum | 661-310A-x | \$76 | | \$76 | |
| Greenhouse, Front, composite | 671-5112-x | \$298 | | \$324 | |
| Greenhouse, Rear, composite | 671-5102-x | \$442 | | \$510 | |
| Hood, flat, composite | 670-3301-x | \$320 | | \$360 | |
| Spoiler, Complete, 4pc, unpainted aluminum blades & brackets, 6-1/2" x 60", 70° | 661-6737 | \$129 | | \$129 | |
| Window, Quarter, mar-resistant coated, 0.093", left | 460-6515BL | \$55 | | \$55 | |
| Window, Quarter, mar-resistant coated, 0.093", right | 460-6515BR | \$55 | | \$55 | |
| Window, Rear, uncoated, 0.093" | 574-6111-3B | \$201 | | \$201 | |
| Windshield, mar-resistant coated, 1/8" | 564-6325-3B | \$357 | | \$357 | |
| COMPLETE BODY PACKAGE PRICE | 593-142-x | \$3,369 | | \$3,599 | |

*ALL WINDOWS ARE PRECUT TO FIT, BEVELED & DRILLED, WITH BLACK-OUT BORDER UNLESS OTHERWISE SPECIFIED.

TO ENHANCE YOUR BODY PACKAGE, CHOOSE FROM THE OPTIONS BELOW:

BODY PACKAGE OPTIONS & UPGRADES (ADD OR SUBTRACT TO PACKAGE PRICE ABOVE FOR TOTAL)

| | | -W | -B | +/- PKG PRICE | -CB | -R | +/- PKG PRICE |
|---|----------------|------------|------------|---------------|--------------|--------------|-----------------------|
| Door, for longer wheelbase, aluminum, left / right (SPECIAL ORDER) (BODY PKG PRICE IS X2) | 661-211A-xLorR | \$112 | \$0 | | \$112 | \$0 | |
| Fender, for 10" tires, Ultraglass composite, left / right (BODY PKG PRICE IS X2) | 663-240-xLorR | \$289 | +\$139 | | \$329 | +\$175 | |
| Fender, for 8" tires, composite, left / right (AVAILABLE ONLY IN BLACK OR WHITE) (BODY PKG PRICE IS X2) | 663-230-xLorR | \$169 | +\$19 | | N/A | N/A | |
| Fender, 8" tires ACT SERIES, high-impact plastic, left / right | 660-23-xLorR | \$150 | \$0 | | N/A | N/A | |
| Greenhouse, Front, advanced lightweight composite | 671-5112L-x | \$524 | +\$226 | | \$524 | +\$200 | |
| Greenhouse, Rear, advanced lightweight composite | 671-5102L-x | \$944 | +\$502 | | \$944 | +\$434 | |
| Hood, flat, advanced lightweight composite | 670-3301L-x | \$585 | +\$265 | | \$585 | +\$225 | |
| Hood, scooped, composite (AVAILABLE ONLY IN BLACK OR WHITE) NOT ABC APPROVED | 660-3303-x | \$320 | \$0 | | N/A | N/A | |
| Quarter Panel, Ultraglass composite, left / right (BODY PKG PRICE IS X2) | 673-270-xLorR | \$314 | +\$180 | | \$370 | +\$228 | |
| Rocker Panels, fits either side, aluminum (BODY PKG PRICE IS X2) | 000-5501A-x | \$39 | +\$6 | | \$39 | \$1 | |
| Cowl Panel Air Deflector, Ultraglass composite (AVAILABLE ONLY IN BLACK) | 000-5200A | \$55 | +\$55 | | N/A | N/A | |
| Windshield, mar-resistant coated, 0.093" | 574-6115-3B | \$315 | +\$114 | | \$315 | +\$114 | |
| Window, Rear, mar-resistant coated, 3/16" (FOR ENHANCED DRIVER SAFETY) | 564-6335-3B | \$397 | +\$40 | | \$397 | +\$40 | |
| Spoilers: 60" wide | 5" (90°) | 5" (70°) | 5" (55°) | 6-1/2" (90°) | 6-1/2" (70°) | 6-1/2" (55°) | |
| Complete, aluminum | 661-6749 | 661-6747 | 661-6745 | 661-6739 | 661-6737 | 661-6735 | \$129 \$0 \$129 \$0 |
| Complete, aluminum, black | 661-6749-B | 661-6747-B | 661-6745-B | 661-6739-B | 661-6737-B | 661-6735-B | \$139 \$10 \$139 \$10 |

ABC GREENHOUSE STYLE

BODY MOUNTING KIT

» EVERYTHING YOU NEED FOR THAT CLEAN & PROFESSIONAL INSTALL!

COMPLETE BODY MOUNTING KIT SAVE \$\$ WHEN PURCHASING COMPLETE KIT VERSUS INDIVIDUAL COMPONENTS!

| | | |
|--|---------------|-----------------|
| Adjustable Body Braces (X3 @ \$35EA) | 807-3 | \$105 |
| Aluminum Nose Side Braces, pair | 000-500 | \$39 |
| Door Vent Windows, pair | 000-6202 | \$35 |
| Front Bumper Mounting Kit | 10001-72721 | \$132 |
| Front Bumper, 1-3/4", .065" steel | 660-7103 | \$48 |
| Graphics, Nose ID Kit (SPECIFY MAKE BELOW) | xx0-410-ID | \$37 |
| Graphics, Bumper Cover ID Kit (SPECIFY MAKE BELOW) | xx0-450-ID | \$36 |
| Hood Pin Bracket, 1/2" steel (5 PINS REQUIRED; SPECIFY MAKE PAGE 129) | xx0-410-HPB | \$35 |
| Hood Pin Kit, 3/8" pins (X3 @ \$15EA) -B -CB -R | 10001-34033-x | \$45 |
| Nose Screen, stainless, 3/16" | 660-4111 | \$50 |
| Rear Bumper Mounting Kit | 802-25 | \$49 |
| Rear Bumper, 1-3/4", .065" steel | 570-7503 | \$48 |
| Rear Deck Mounting Kit | 660-450-RDK | \$87 |
| Rear Window Brace Kit (3PC) | 674-6101 | \$76 |
| Right Side Door Support | 11002-75533 | \$30 |
| Universal Body Mounting Kit, plastic | 00001-72651 | \$29 |
| Wear Strips, plastic SPECIFY COLOR: -W -B -CB -OR -R -Y -FG -FO -FR -FY | 000-400-x | \$35 |
| Window Installation Kit | 805 | \$23 |
| Windshield Brace Kit (3PC) | 564-6301 | \$76 |
| COMPLETE KIT PRICE WITH 10% DISCOUNT | 800-1D | \$913.50 |

BODY MOUNTING KIT OPTIONS & UPGRADES (ADD OR SUBTRACT GREEN \$ TO PACKAGE PRICE ABOVE FOR TOTAL)

| | | | | | | | |
|---|--------------|------|-------|--|--------------|------|-------|
| Front Bumper, 1-3/4" round, .095" steel | 660-7103B | \$48 | \$0 | Nose Screen, 1/4" spacing | 660-4112 | \$50 | \$0 |
| Front Bumper, 1-3/4" round, .095" steel W/12" EXT | 660-7103C | \$56 | +\$8 | Nose Screen, black, 1/4" spacing | 660-4112-B | \$55 | +\$5 |
| Hood Pin Bracket, 3/4" aluminum (SPECIFY MAKE PG 129) | xx0-411A-HPB | \$66 | +\$31 | Nose Screen, black, 3/16" spacing | 660-4111-B | \$55 | +\$5 |
| Hood Pin Bracket, 3/4" steel (SPECIFY MAKE PG 129) | xx0-411-HPB | \$35 | +\$0 | Nose Screen, black aluminum frame, 3/16" | 10001-46333B | \$55 | +\$5 |
| Hood Pin Kit, 1/2" pins (5PC) | 803 | \$38 | -\$7 | Nose Screen, black aluminum frame, 1/4" | 10001-46433B | \$55 | +\$5 |
| | | | | Universal Body Mounting Kit, aluminum | 000-400K | \$49 | +\$20 |

VINYL NOSE & BUMPER COVER GRAPHIC ID KITS FOR A REALISTIC OEM LOOK!

PRINTED ON OUTDOOR DURABLE HIGH-TACK VINYL • GLOSSY LAMINATED SURFACE PROVIDES EXCELLENT PROTECTION



CHEVROLET SS

| | | |
|---------------------|------------|------|
| Nose ID Kit | 680-410-ID | \$37 |
| Bumper Cover ID Kit | 680-450-ID | \$36 |



FORD FUSION

| | | |
|---------------------|------------|------|
| Nose ID Kit | 500-410-ID | \$37 |
| Bumper Cover ID Kit | 500-450-ID | \$36 |



TOYOTA CAMRY

| | | |
|---------------------|------------|------|
| Nose ID Kit | 740-410-ID | \$37 |
| Bumper Cover ID Kit | 740-450-ID | \$36 |



DODGE CHARGER

| | | |
|---------------------|------------|------|
| Nose ID Kit | 470-410-ID | \$37 |
| Bumper Cover ID Kit | 470-450-ID | \$36 |

Dodge Charger Nose & Bumper Cover are only available in Black or White

» GO TO PAGES 124-147 TO SEE ALL ACCESSORIES FOR THIS BODY

PRICING SUBJECT TO CHANGE WITHOUT NOTICE

ABC GREENHOUSE STYLE

FEATURED BODY ACCESSORIES

WIDE ANGLE RACING MIRROR:

- » This convex glass mirror gives you the best view of your competition!
- » All black frame with black anodized machined aluminum brackets
- » For more details & ordering info page 146



SPOILER MOUNTING KIT:

- » Everything needed to mount the polycarbonate spoiler blade to the bracket, and the bracket to the bumper cover
- » For more details & ordering info page 138

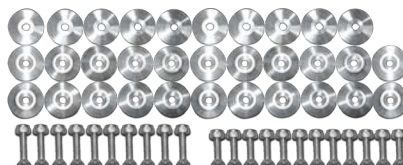

UNIVERSAL BODY MOUNTING KIT:

- » Universal fit that can be used anywhere on a race car
- » Plastic kit features Black Delrin washers that withstand repeated impact and stress
- » For more details & ordering info page 127



PREMIUM AVEX STYLE RIVETS:

- » Five Star Premium Rivets are known as the best quality on the market
- » Super-tight grip and won't spin out while drilling!
- » Grip range of up to 3/16" for 1/8" rivets and up to 1/2" for 3/16" rivets
- » For more details & ordering info page 126

» GO TO PAGES 124-147 TO SEE ALL ACCESSORIES FOR THIS BODY STYLE

ABC GREENHOUSE STYLE

BODY DIMENSIONS

ABC
LMSC
TRUCK
PAV/MODIFIED
OUTLAW/LATE MODEL
SPORTSMAN
STREET STOCK
MOD LATE MODEL
MOD MODIFIED
DIRT GRAND NAT'L
T&Z
PRO STOCK/MOD
FUNNY CAR
WINDOWS
ACCESSORIES

FIVE STAR BODIES ARE DESIGNED TO MAINTAIN PRECISE FIT WITH OPTIMIZED AERODYNAMICS!

WIDTHS

| A | B | C |
|-------------------------------------|--|--|
| 79½" MAX" | 68" | 67" |
| Body Width: Measured at wheel wells | Door to Door Width: Measured at A-posts & inside edge of doors, measured through car | Door to Door Width: Measured at B-posts & inside edge of doors, measured through car |

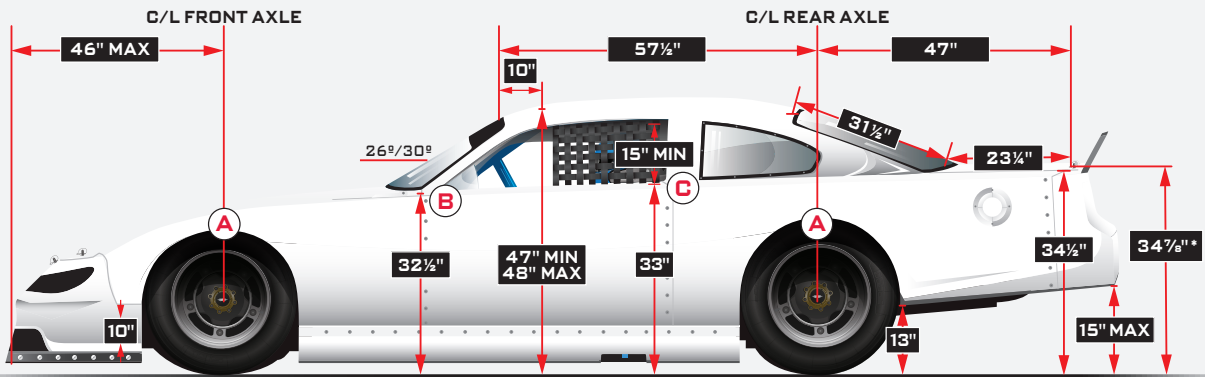

NOTES:

1. If the Roof Height (10" back from windshield), Door Height (rear), Quarter Panel, or Bumper Cover Height dimensions are higher than the stated minimum dimensions, all four must increase by the same amount.

2. Must fit centerline template within allowable tolerance. *Measured at the seam of bumper cover at deck lid intersection, +/- 1/4"

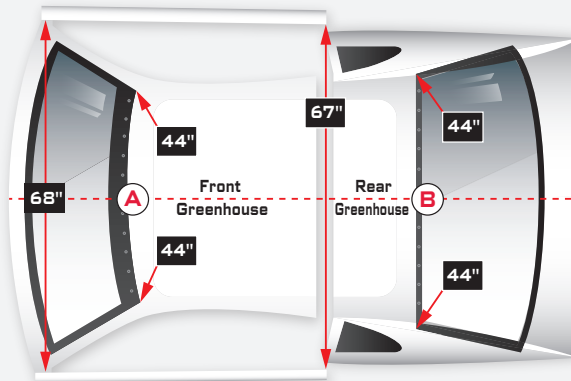

| CHASSIS | ROOF HEIGHTS | TREAD WIDTH | WHEELBASE |
|-----------------------|--------------|-------------|-----------|
| Offset/ Straight Rail | A 47" B 45½" | 66" MAX | 101-108" |

BODY PANEL



DIMENSIONS

FOR INDIVIDUAL BODY PANEL DIMENSIONS, VISIT FIVESTARBODIES.COM

ABC GREENHOUSE STYLE

BODY MOUNTING FIXTURES

MOUNT YOUR BODY FAST & EASY TO MAXIMIZE PERFORMANCE & TO PASS TECH INSPECTION!

It is the responsibility of all competitors to present a car that fits the templates within allowable tolerances and meets all dimensions as inspected by the "Referee." Be sure to download a free copy of the Official ABC Rulebook for body styles, panels, spoilers, windows, overhangs, roof height, proper placement of templates, and more!



THE OFFICIAL REFEREE 2.0

- » Used by tracks and associations throughout North America for body tech inspection
- » Measure the front overhang of the nose, tread width, roof, door, and deck height, rear overhang, wheelbase, and engine setback
- » Adjustable laser option for accurate measurements of front overhang and engine setback
- » Magnetic, tinted polycarbonate wheel plates for better attachment to wheels
- » Includes Tech Inspector's checklist
- » **NOT NECESSARY FOR MOUNTING A BODY.** A body can easily be installed within specs by using the body dimensions sheets & templates

| | | |
|---|-----------|---------|
| Referee 2.0 | TT-200-00 | \$1,975 |
| Wheel Locator, w/magnets (SET OF 4) (SOLD SEPARATELY) | TT-200-WL | \$98 |
| Laser Measurement Assembly (SOLD SEPARATELY) | TT-200-LB | \$150 |

VISIT OUR YOUTUBE PAGE FOR A TECH VIDEO DEMONSTRATING USE OF THE OFFICIAL REFEREE 2.0

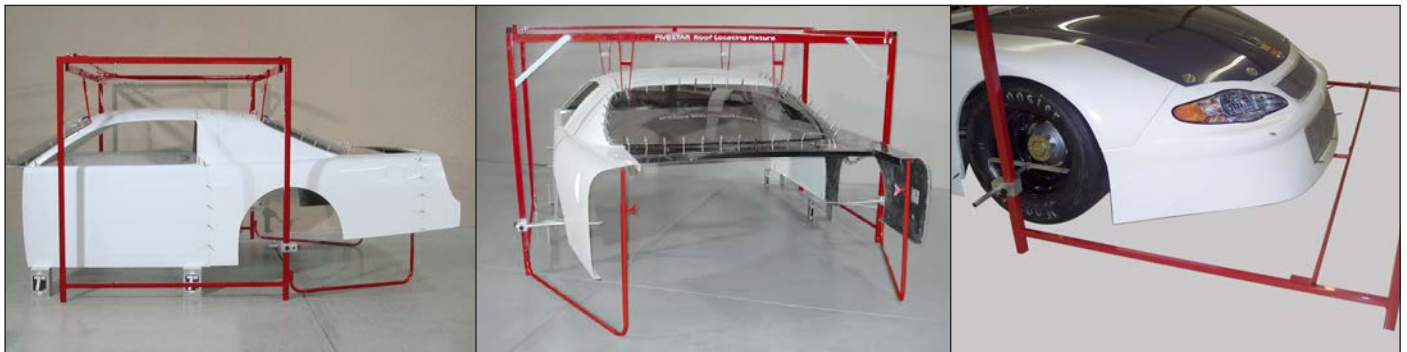

ROOF LOCATING FIXTURE

- » THE FAST & EASY WAY TO MOUNT YOUR COMPLETE BODY WITHOUT THE CHASSIS UNDERNEATH
- » This time-saving device has adjustable quarter panel arms and makes locating the roof on your chassis a simple process
- » Allows exact fit for wheel opening locations, body dimensions, and inspection templates to fit series specs
- » Pre-fits from the cowl to the bumper cover, then can be lifted easily on top of the chassis for final fit
- » Comes in a black powder-coat finish and includes roof brackets, door height blocks and assembly instructions

| | | |
|---|--------|-------|
| Roof Locating Fixture (includes Roof Brackets & Door Height Blocks) | 809P | \$875 |
| Replacement Roof Brackets | 809-1P | \$71 |
| Replacement Door Height Blocks, 7" tall | 809-HB | \$38 |

ABC GREENHOUSE STYLE

TOOLS & TEMPLATES

ABC
LMSC TRUCK
TRUCK
PAV/MODIFIED
OUTLAW/LATE MODEL
SPORTSMAN
STREET STOCK
M03 LATE MODEL
M03 MODIFIED
DIRT GRAND NAT'L
T&Z
PRO STOCK/MOD
FUNNY CAR
WINDOWS
ACCESSORIES



ABC TEMPLATES ENSURE A CORRECT FIT FOR OPTIMUM AERODYNAMICS

- » Complete template set ensures body is installed correctly
- » Complete sets include: Body Centerline, Fenders, Nose Centerline, Rear Roof Side-to-Side
- » Common templates can check all models
- » Master sets available with templates for all models

| | | |
|---|-------------|-------|
| Template, Complete Set, wood, Chevrolet SS | 660-82 | \$183 |
| Template, Complete Set, wood, Ford Fusion | 570-82 | \$183 |
| Template, Complete Set, wood, Toyota Camry | 660-82 | \$183 |
| Template, Nose Side-to-Side, wood, Common | XA 672-82NS | \$64 |
| NEW! TEMPLATES: ENHANCED SHAPE CONTROL FOR 2024 | | |
| Template, Roof, Front, Side-to-Side, extended, wood, Common | XA 660-82W | \$49 |
| Template, Roof, Rear, Side-to-Side, extended, wood, Common | XA 660-82S | \$49 |
| Template, Rear Deck Lid, wood, Common | XA 660-82RD | \$49 |

RULEBOOK



QR CODE

» **DOWNLOAD OFFICIAL ABC RULEBOOK @ FIVESTARBODIES.COM**



» **FOR MORE BODY MOUNTING TOOLS, GO TO PAGES 124-147**

PRICING SUBJECT TO CHANGE WITHOUT NOTICE



BODY MOUNTING TOOLS, BRACING & ACCESSORIES

***PRODUCTS ESSENTIAL FOR A COMPLETE, CLEAN,
PROFESSIONAL-LOOKING RACE CAR***



- » **MOUNTING TOOLS:** Facilitate a professional body installation, & replace panels throughout the season quick & hassle-free
- » **UNIVERSAL BRACING:** Support body panels with these lightweight components essential to achieving astounding aerodynamics
- » **ACCESSORIES:** Everything you need to give you race car that finishing touch!

FIVE STAR PREMIUM AVEX STYLE MULTI-GRIP RIVETS *THE BEST QUALITY ON THE MARKET*

- » Five Star Rivets have a super-tight grip & won't spin while drilling
- » Grip range of up to 3/16" for 1/8" rivets & up to 1/2" for 3/16" rivets
- » Use long shank rivets for fastening fender, door, & windshield post together
- » Sold in quantities of 100 & 500; large head & small head with choice of 1/8" unpainted or 3/16" unpainted, white, black, blue, red



| SIZE/DESCRIPTION | QTY | SMALL | LARGE | |
|------------------|-----|-----------|-----------|------|
| 3/16", color | 100 | 814x-100S | 814x-100L | \$17 |
| 3/16", unpainted | 100 | 816-100S | 816-100L | \$17 |
| 3/16" long shank | 100 | 816A-100S | N/A | \$19 |
| 3/16", color | 500 | 814x-500S | 814x-500L | \$68 |
| 3/16", unpainted | 500 | 816-500S | 816-500L | \$55 |
| 1/8", unpainted | 100 | 815-100S | 815-100L | \$13 |
| 1/8", unpainted | 500 | 815-500S | 815-500L | \$50 |

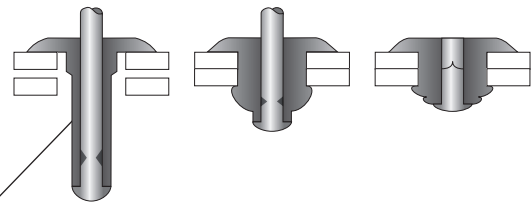

Provide a secure installation of your body panels with Five Star Rivets & Washers!

Five Star Rivets pull much tighter than other, cheaper rivets.

Washers are oversized to fit with Five Star Rivets and keep rivets tight no matter how much vibration



FIVE STAR PREMIUM WASHERS

- » Five Star Premium Washers are lightweight & available in 3 sizes
- » Recommended for all plastic & composite body panels to keep them tight & prevent rivets from pulling out

| TYPE | SIZE (I.D.) | SIZE (O.D.) | QTY | | |
|----------|-------------|-------------|-----|-----------|------|
| Standard | 1/8" | 3/8" | 100 | 817-100A | \$9 |
| Standard | 1/8" | 3/8" | 500 | 817-500A | \$25 |
| Standard | 3/16" | 1/2" | 100 | 818-100A | \$9 |
| Standard | 3/16" | 1/2" | 500 | 818-500A | \$25 |
| Large | 3/16" | 3/4" | 100 | 818-100AL | \$9 |
| Large | 3/16" | 3/4" | 500 | 818-500AL | \$25 |

HIGH-IMPACT PLASTIC WEAR STRIPS

- » Height adjustable to seal the nose to the track to optimize aero & protection from wear
- » CNC-machined from Five Star's exclusive durable plastic
- » 2-piece kit fits either side
- » Install with Five Star Wear Strip Attach Kits
- » Available in 10 colors

| | | | |
|---|---------------|---------------|------|
| ABC NextGen, NextGen LMSC Wear Strips | 116" x 1-7/8" | 11002-41551-x | \$35 |
| ABC, LMSC, Straight-up Metal, Dirt Grand National Wear Strips | 112" x 2-3/4" | 000-400-x | \$35 |
| S2 Sportsman Wear Strips | 111" x 3" | 664-400-x | \$42 |
| Classic Street Stock (N/A IN FLUORESCENT COLORS) | 120" x 5" | 600-400-x | \$41 |
| MD3 Street Stock, '88 Monte Carlo Wear Strips | 119" x 3" | 021-400-x | \$41 |
| Modern Style Street Stock, North American Sportsman Wear Strips | 107" x 3" | 20002-41551-x | \$38 |

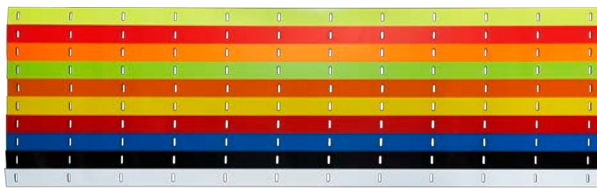

11002-41551-X

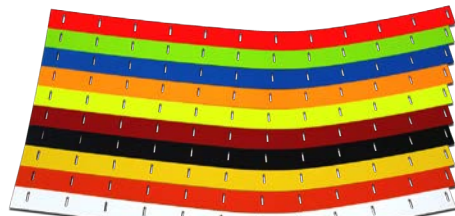

000-400-X



11002-41551-Y YELLOW WEAR STRIPS FULLY INSTALLED WITH 00001-72651 UNIVERSAL BODY MOUNTING KIT

KITS SPEED UP WEAR STRIP INSTALLATION & ALLOW FOR ADJUSTABILITY OF WEAR STRIP IF NEEDED



FULLY ASSEMBLED PLASTIC

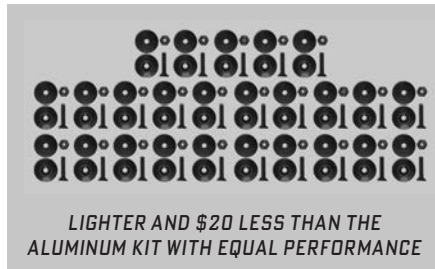

LIGHTER AND \$20 LESS THAN THE ALUMINUM KIT WITH EQUAL PERFORMANCE



FULLY ASSEMBLED ALUMINUM

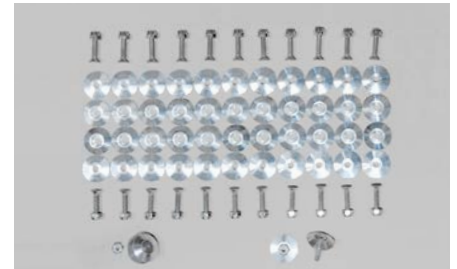

UNIVERSAL BODY MOUNTING KITS

- » Universal fit that can be used anywhere on a race car
- » Plastic Kit comes in all black & features Delrin washers that withstand repeated impact & stress
- » **Aluminum Kit includes:** 25 lightweight machined aluminum inner & outer 1" diameter washers, 25 nuts & 25 bolts. Kit weighs 12 oz
- » **Plastic Kit includes:** 25 ultra-durable plastic inner & outer 1" diameter washers, 25 lightweight aluminum nuts & 25 bolts.
- » Kit weighs 7 oz

| | | |
|---------------------------------------|-------------|------|
| Aluminum: 25 sets (FULL INSTALLATION) | 000-400K | \$49 |
| Plastic: 25 sets (FULL INSTALLATION) | 00001-72651 | \$29 |

FRONT BUMPERS

- » Formed using CNC progressive tube bending technology
- » Fits the exact contour of Five Star noses for maximum protection and ease of installation
- » Formed from 1-3/4" OD round steel tubing
- » For a complete secure mount, it is recommended to install your bumpers with Five Star's Front Bumper Mounting Kits

| ABC NEXTGEN | | |
|---|-------------|------|
| Front, .065" steel | 11002-71182 | \$48 |
| Front, .095" steel | 11002-71185 | \$48 |
| Front, .095" steel (12" EXT RIGHT SIDE) | 11002-71188 | \$56 |
| NEXTGEN LMSC | | |
| Front, .065" steel | 13002-71182 | \$48 |
| Front, .095" steel | 13002-71185 | \$48 |
| Front, .095" steel (12" EXT RIGHT SIDE) | 13002-71188 | \$56 |
| ABC / LMSC / STRAIGHT-UP METAL | | |
| Front, .065" steel | 660-7103 | \$48 |
| Front, .095" steel | 660-7103B | \$48 |
| Front, .095" steel (12" EXT RIGHT SIDE) | 660-7103C | \$56 |

| NORTH AMERICAN SPORTSMAN | | |
|-------------------------------|-------------------|------|
| Front .065" steel | 20002-71182 | \$48 |
| STREET STOCK '88 MONTE CARLO | | |
| Front, .065" steel | 600-7103 | \$48 |
| Front, .095" steel | 600-7103B | \$48 |
| Front, .065" steel | 600-7101 (SQUARE) | \$48 |
| STREET STOCK CAMARO & MUSTANG | | |
| Front, .065" steel | 20002-71182 | \$48 |
| DIRT GRAND NATIONAL | | |
| Front, .065" steel | 700-7103 | \$48 |
| Front, .095" steel | 700-7103B | \$48 |
| SHORT TRACK TRUCK COMMON | | |
| Front, .065" steel | 21001-71162 | \$48 |

FRONT BUMPER MOUNTING KIT (HIGHLIGHTED IN ORANGE)
WITH BLACK ADJUSTABLE BUMPER SUPPORTS



.095" STEEL BUMPER WITH
12" EXTENSION FOR
ADDITIONAL RIGHT FRONT
PROTECTION

CLOSE-UP OF
ADJUSTABLE
BUMPER SUPPORT

FRONT BUMPER MOUNTING KITS

- » Everything you need to mount the bumper to the chassis
- » Upgraded lightweight, extruded, black anodized aluminum adjustable bumper supports
- » Make quick, easy, & accurate adjustments with a 5/8" wrench
- » Universal design for all Five Star Short Track Noses
- » Fits all chassis configuration
- » **Complete Kit includes:** 2 aluminum threaded bumper support tubes; 4 clevis, eye bolts & nuts; 2 1-1/2" pieces of square tubing, notched on one end; 2 pieces of flat stock; 4 1-1/2" bolts & stover nuts, 2 pivoting chassis mounts with 2-1/2" bolts & nuts
- » **Adjustable Bumper Support Kit includes:** 2 extruded, threaded, black anodized aluminum adjustable tubes; 4 eye bolts & nuts; 4 1-1/2" bolts and stover nuts
- » **Replacement Kit includes:** 2 1-1/2" square pieces of square tubing; 2 pieces of flat stock; 1/2" nuts & bolts & mounting tabs

| | | |
|---------------------------|-------------|-------|
| Complete Kit | 10001-72721 | \$132 |
| Adjustable Bumper Support | 10001-72733 | \$29 |
| Replacement Kit | 802-4 | \$87 |

10001-72721 | COMPLETE KIT

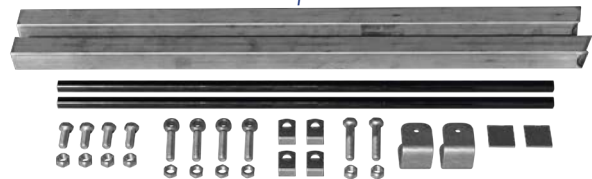

802-4 | REPLACEMENT KIT



10001-72733 | ADJUSTABLE BUMPER SUPPORTS KIT



HOOD PIN BRACKETS

- » Preformed to fit the nose & hood precisely
- » Aluminum option weighs less than half of steel
- » Both options include welded-on tabs for hood pin placement
- » Aluminum bracket includes welded on mounting tabs on each end to brace to the front bumper mounting kit for added support
- » ABC NextGen / NextGen LMSC require 4 hood pins & Old Style ABC/LMSC require 5 hood pins
- » Available in 1/2" & 3/4" options, & will work for both 1/2" & 3/8" hood pins

| ABC NEXTGEN / NEXTGEN LMSC: | | |
|-----------------------------------|--------------|------|
| 3/4" OD, aluminum (COMMON) | 11002-34333 | \$66 |
| 3/4" OD, steel (COMMON) | 11002-34331 | \$35 |
| OLDER STYLE ABC / LMSC: | | |
| 3/4" OD, aluminum (EXCLUDES FORD) | 660-411A-HPB | \$66 |
| 3/4" OD, aluminum (FORD) | 570-411A-HPB | \$66 |
| 3/4" OD, steel (EXCLUDES FORD) | 660-411-HPB | \$35 |
| 3/4" OD, steel (FORD) | 570-411-HPB | \$35 |
| 1/2" OD, steel (EXCLUDES FORD) | 660-410-HPB | \$35 |
| 1/2" OD, steel (FORD) | 570-410-HPB | \$35 |
| NORTH AMERICAN SPORTSMAN: | | |
| 3/4" OD, steel | 20002-34331 | \$35 |

| S2 SPORTSMAN: | | |
|---------------------------------------|-------------|------|
| 3/4" OD, steel | 664-411-HPB | \$35 |
| 1/2" OD, steel | 664-410-HPB | \$35 |
| SHORT TRACK TRUCK: | | |
| 1/2" OD, steel (COMMON) | 21001-34131 | \$35 |
| STREET STOCK: | | |
| 3/4" OD, steel ('88 MONTE CARLO) | 600-410-HPB | \$35 |
| 3/4" OD, steel (MD3 CAMARO & MUSTANG) | 20002-34331 | \$35 |
| DIRT GRAND NATIONAL: | | |
| 1/2" OD, steel (EXCLUDES FORD) | 700-410-HPB | \$35 |
| 1/2" OD, steel (FORD) | 703-410-HPB | \$35 |

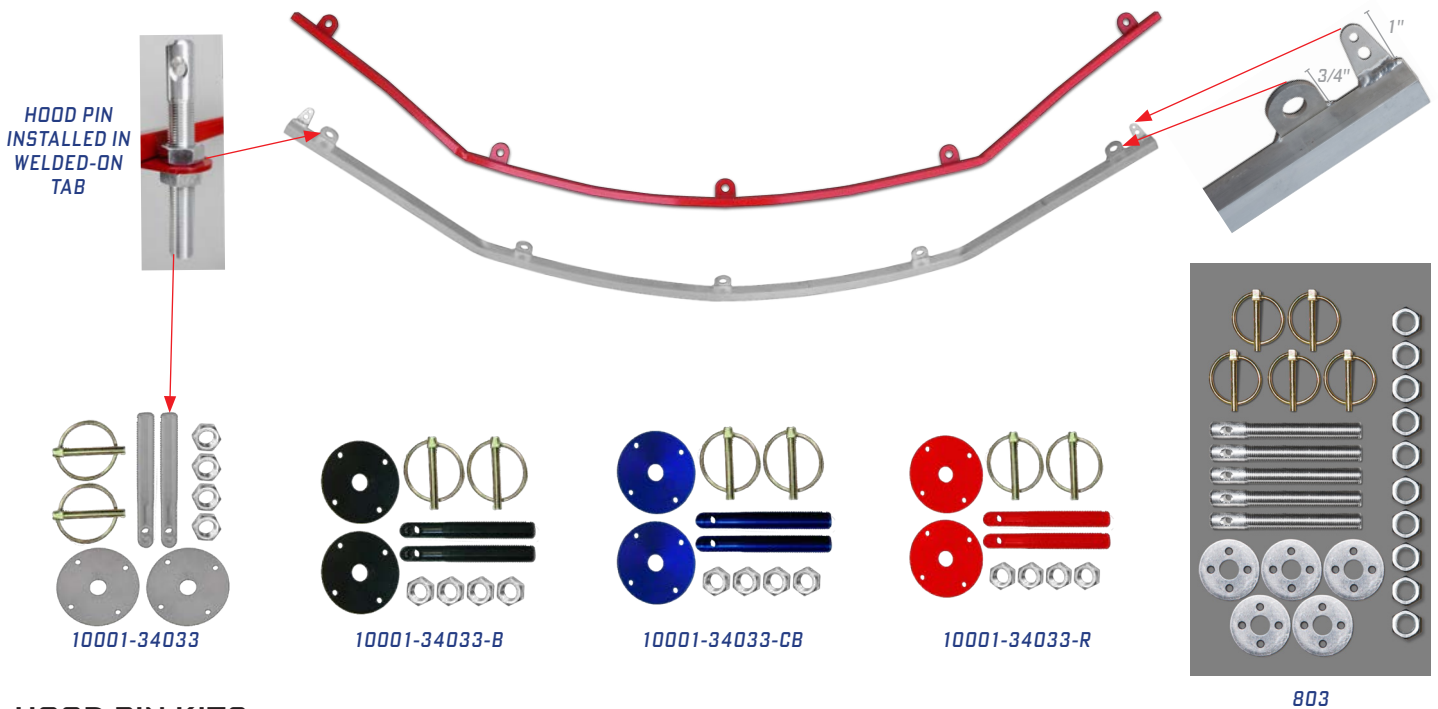

HOOD PIN KITS

- » **Secure your hood in style!**
- » **3/8" Hood Pin Kit:** 2 pack kit includes: 2 lightweight anodized & gun-drilled aluminum pins (HALF THE WEIGHT OF STANDARD), 2 aluminum scuff plates, 2 flip-over steel clips, 4 jam nuts
- » **1/2" Hood Pin Kit:** 5 pack kit includes: 5 lightweight aluminum pins, 5 aluminum scuff plates, 5 flip-over style steel clips, 10 jam nuts

| | | |
|----------------------------|----------------|------|
| 3/8" Hood Pin Kit, Silver | 10001-34033 | \$15 |
| 3/8" Hood Pin Kit, Black | 10001-34033-B | \$15 |
| 3/8" Hood Pin Kit, Red | 10001-34033-R | \$15 |
| 3/8" Hood Pin Kit, Blue | 10001-34033-CB | \$15 |
| 1/2" Hood Pin Kit, 5 pack | 803 | \$38 |
| 1/2" Scuff Plate, aluminum | 803-PS | \$2 |

ABC LMSC TRUCK RAV/MODIFIED OUTLAW/LATE MODEL SPORTSMAN STREET STOCK MD3 LATE MODEL MD3 MODIFIED DIRT GRAND NAT'L T&2 PRO STOCK/MOD FUNNY CAR WINDOWS ACCESSORIES



FULLY INSTALLED UNDERNEATH THE LOWER NOSE VALANCE (LEFT SIDE SHOWN)



ALUMINUM
11002-75733

42-1/2"

LOWER NOSE SUPPORT BRACKET

- » Mounts under the lower valance to maintain strength & structural integrity for the nose under high speeds
- » Choose from a lightweight aluminum or steel bracket
- » Fits left & right half of nose
- » **2-piece kit includes: 2 brackets with 2 attached mounting tabs for ease of installation**

| | | |
|----------|-------------|------|
| Aluminum | 11002-75733 | \$49 |
| Steel | 11002-75731 | \$44 |

FITS THESE BODY STYLES: ABC NEXTGEN, NEXTGEN LMSC



000-500: MOUNT TO INSIDE OF WEAR STRIPS WITH A FIVE STAR UNIVERSAL BODY MOUNTING KIT



11002-75333: MOUNT VERTICALLY ON NOSE SIDE

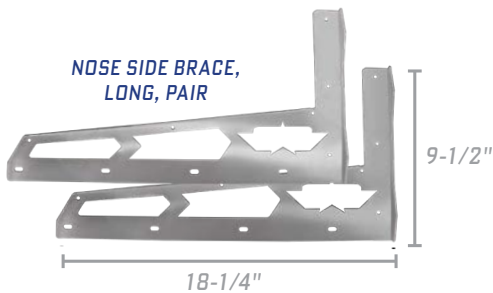

NOSE SIDE BRACE, LONG, PAIR

18-1/4"

9-1/2"



9-7/8"

NOSE SIDE BRACE, SHORT, PAIR

2"

ALUMINUM NOSE SIDE BRACES

- » Provides structure to an aero critical part of the car
- » Laser-cut aluminum is pre-drilled for riveting to the nose & for mounting body braces
- » Works great with Five Star's Premium Adjustable Body Braces (PN 10001-759XX)
- » Each pair weighs less than a pound

| | | |
|--|-------------|------|
| Nose Side Brace, Long, pair | 000-500 | \$39 |
| FITS THESE BODY STYLES: OLDER STYLE ABC AND OLDER STYLE LMSC, FIBERGLASS SPORTSMAN, STRAIGHT UP METAL, DIRT GRAND NATIONAL, MINI STOCK MUSTANG | | |
| Nose Side Brace, Short, pair | 11002-75333 | \$14 |

FITS THESE BODY STYLES: ABC NEXTGEN, NORTH AMERICAN SPORTSMAN, NEXTGEN LMSC, SHORT TRACK TRUCK

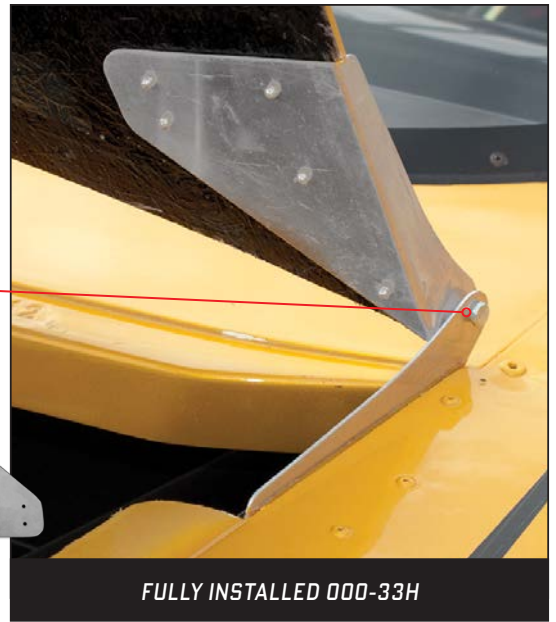
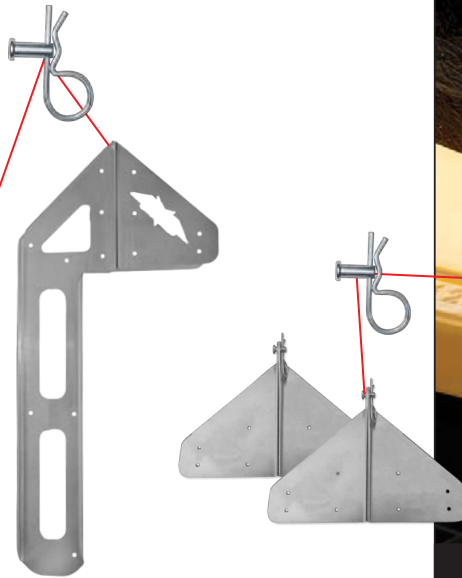

ALUMINUM HOOD HINGE KITS

- » Hinged hoods create easy access to the engine compartment
- » Long Hinge Kit includes: Laser cut aluminum hinge, pin, & clip assembly. 1 kit is required to complete the installation of a hood
- » Short Hinge Kit includes: Laser cut aluminum hinge, pin, & clip assembly. 2 kits are required to complete the installation of a hood

| | | |
|------------------------|-------------|------|
| Hood Hinge, short | 000-33H | \$16 |
| Hood Hinge, long | 11002-73333 | \$39 |
| Replacement Pin & Clip | 000-33HP | \$4 |

ALUMINUM HOOD PROP

- » Makes for the easiest access to the engine compartment
- » Made of machined lightweight aluminum
- » Used for hinged hoods
- » Sold as a pair, 2 needed for installation

| | | |
|-----------------|----------|------|
| Hood Prop, pair | 000-3400 | \$67 |
|-----------------|----------|------|

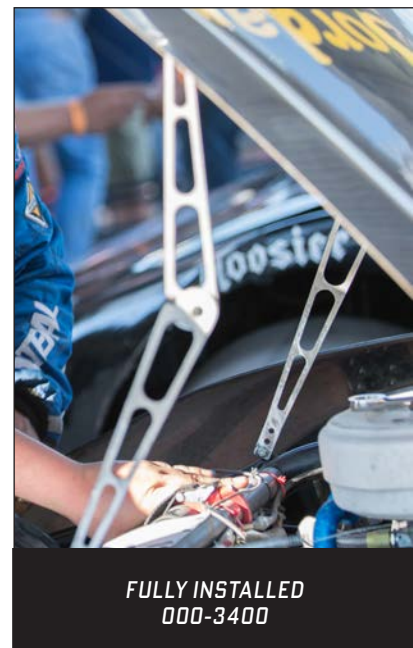



000-408 FULLY INSTALLED



11002-42151 FULLY INSTALLED

MOLDED PLASTIC RADIATOR DUCTS

- » Universal multi piece design for easy installation to fit any chassis and radiator size/offset
- » High air flow design
- » Premium molded plastic weighs less than 13 lbs
- » More durable and easier to install than other sheet metal air boxes
- » 100% positive seal from nose to radiator
- » Access panel for easy debris clean-out
- » 000-408 for short track bodies, includes Plastic Nose Air Inlet Extension
- » The Plastic Nose Air Inlet Extension is not needed for the ABC NextGen & Late Model Stock Car NextGen

| | | |
|-------------------------------|-------------|-------|
| Universal Short Track Bodies* | 000-408 | \$221 |
| ABC NextGen / NextGen LMSC | 11002-42151 | \$185 |

*FITS THESE BODY STYLES: ABC, LMSC, NORTH AMERICAN SPORTSMAN, S2 SPORTSMAN, STRAIGHT-UP METAL, STREET STOCK



*NOTE: FOR COMPLETE INSTALLATION GUIDE VISIT FIVESTARBODIES.COM/RESOURCES

PLASTIC BRAKE DUCT KIT

- » Provide peak airflow to cool your brakes
- » Universal fit for all noses at correct angle; fits either side
- » Fits 3" & 4" Brake Duct hose
- » Kit includes: pre-cut stainless steel screen, rivets & washers
- » Weighs 6 oz

| | | |
|------------|----------|------|
| Brake Duct | 000-412D | \$35 |
|------------|----------|------|

FITS THESE BODY STYLES: ABC NEXTGEN, ABC, NEXTGEN LMSC, LMSC, S2, SHORT TRACK TRUCK, NORTH AMERICAN SPORTSMAN, STRAIGHT-UP METAL, STREET STOCK

ONLY WEIGHS 6 OZ



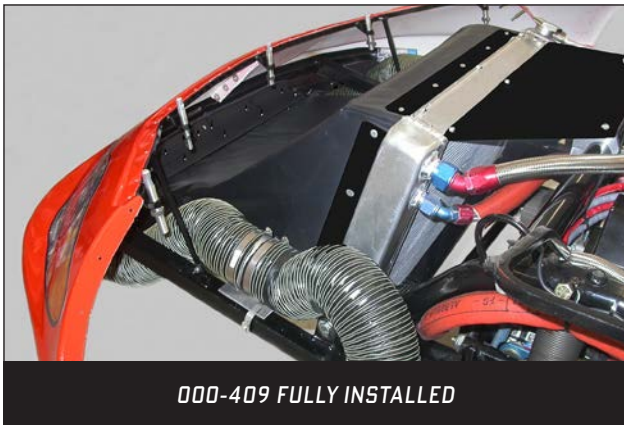

000-409 FULLY INSTALLED



STREET STOCK
FLEXIBLE RADIATOR DUCT

FLEXIBLE RADIATOR DUCTS

- » Retains air flow functionality even after frontal impact & reduces the risk of radiator damage
- » Flexible Radiator Duct replaces rigid metal ductwork with a custom canvas bag & aluminum or plastic framing
- » Long lasting & durable
- » Simple installation
- » Select your model by measuring the size of the radiator core
- » Features molded plastic radiator mounting flanges
- » Plastic Nose Air Inlet Extension (PN 000-409-NP) used for 000-409 Radiator Ducts only

Street Stock (PN 600-409)

- » Fits both '88 Monte Carlo Noses
- » Captures air from both the upper & lower nose grill openings

| ABC/NORTH AMERICAN SPORTSMAN/S2/SU | | STYLE/SIZE | ABC NEXTGEN/NEXTGEN LMSC | |
|------------------------------------|-------|----------------------------|--------------------------|-------|
| 000-409-1 | \$169 | Griffin, 22-3/8" x 17-7/8" | 11002-42120 | \$135 |
| 000-409-2 | \$169 | Howe, 24-1/4" x 18-1/2" | 11002-42121 | \$135 |
| 000-409-3 | \$169 | Howe, 22-1/4" x 18-3/4" | 11002-42122 | \$135 |
| 000-409-4 | \$169 | C & R, 22-1/4" x 17-3/4" | 11002-42123 | \$135 |
| 000-409-5 | \$169 | C & R, 24-1/4" x 17-3/4" | 11002-42124 | \$135 |
| 000-409-6 | \$169 | Howe, 27-1/4" x 18-1/2" | 11002-42125 | \$135 |
| LMSC | | STYLE/SIZE | STREET STOCK | |
| 000-409-5 | \$169 | C & R, 24-1/4" x 17-3/4" | 11002-42124 | \$135 |
| 000-409-6 | \$169 | Howe, 27-1/4" x 18-1/2" | 11002-42125 | \$135 |

PLASTIC NOSE AIR INLET EXTENSION

- » Ideal for racers who build their own aluminum radiator box
- » Molded Plastic construction & weighs less than 2 lbs
- » The Plastic Nose Air Inlet Extension is not needed for the ABC NextGen & Late Model Stock Car NextGen
- » Item already included with 000-408 Molded Plastic Radiator Duct & 000-409 Flexible Radiator Duct

| | | |
|----------------------------------|------------|------|
| Plastic Nose Air Inlet Extension | 000-409-NP | \$36 |
|----------------------------------|------------|------|

FITS THESE BODY STYLES: ABC, LMSC, NORTH AMERICAN SPORTSMAN, S2 SPORTSMAN, STRAIGHT-UP METAL



SHOWN MOUNTED FROM INSIDE OF NOSE

DETAILS AND



DIMENSIONS

ABC LMSC TRUCK RAV/MODIFIED OUTLAW/LATE MODEL SPORTSMAN STREET STOCK M03 LATE MODEL M03 MODIFIED DIRT GRAND NATL TAZ PRO STOCK/MOD FUNNY CAR WINDOWS ACCESSORIES



FULLY INSTALLED COLD AIR BOX

COWL INDUCTION COLD AIR BOXES

FLOW BENCH TESTED FOR PEAK AIRFLOW

- » Advanced lightweight composite construction with flame retardant gray resin
- » Comparable in weight to carbon fiber alternatives
- » Designed for maximum airflow using air filters as short as 3"
- » Increased distributor & under hood clearance
- » Fits a standard 14" filter element

| | | |
|-------------------------------|-------------|-------|
| 4 Barrel, 0° Angle (Offset) | 10001-53401 | \$568 |
| 4 Barrel, 3° Angle (Standard) | 10001-53431 | \$568 |
| 2 Barrel, standard | 10001-53201 | \$426 |
| 2 Barrel, offset | 10001-53202 | \$406 |

NOTE: FOR OLDER STYLE 51-SERIES COLD AIR BOXES CALL FIVE STAR 262.877.2171



2 BARREL COLD AIR BOX

4 BARREL AIR BOXES:

- » Available in 0° & 3° to ensure a proper, level fit
- » Feature a patented machined adapter ring for clean airflow, better fit, & durability
- » 3° Airbox is commonly used for short track Late Models
- » How to determine air box angle option:
 - » Set car at proper ride height
 - » Place angle finder on carburetor to determine which air box option fits bests



4 BARREL COLD AIR BOX

2 BARREL OFFSET AIR BOX:

- » Offset 2-barrel air box is for engines with a larger setback
- » Designed to allow the element to be flat across the back for engine setback & clearance in the cowl
- » Fits a standard 3-1/2" x 14" filter element

2 BBL AIR BOX IS DYNO TESTED

"The results were outstanding! Five Star's 2bbl Air Box was 10 HP & 16 ft lbs of torque better than the old one!"

-SHANE HARDING
HARDING MOTORSPORTS CHASSIS

PATENTED FLOW DESIGN

4 BBL UNIQUE HIGH FLOW DESIGN
CNC-machined aluminum ring (laminated into the air box) fits perfectly on carburetor to maximize airflow

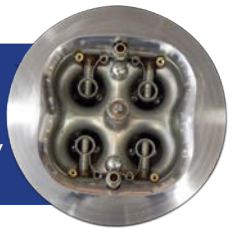

DETAILS AND



DIMENSIONS

» FOR INDIVIDUAL PART DIMENSIONS, VISIT FIVESTARBODIES.COM

REFLECTIVE HEAT SHIELD KITS

- » Thin reflective adhesive film reflects over 90% of radiant heat from the engine, up to 500°F
- » Easy to cut and install to protect any part of the race car from high heat:
 - » All Cold Air Boxes
 - » Interiors
 - » Foot Boxes
 - » Shock Canisters
 - » Fuel Filter Housings
 - » And more

| | | |
|---------------------------------|----------|------|
| Cold Air Box Kit, 4 oz | 000-52HS | \$74 |
| 5'x26" Length Sheet, 3oz per ft | 000-5HS | \$74 |



FULLY INSTALLED COLD AIR BOX KIT 000-52HS

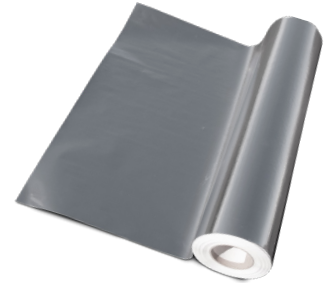

5' LENGTH SHEETS 000-5HS

ROUNDED BOTTOM | 000-5200A



SQUARE BOTTOM | 000-5100A-B



COWL AIR DEFLECTORS

- » Smoothly flows air from cowl air opening into cold air box
- » Black Ultraglass Composite
- » Rounded Bottom: 20" x 7", Square Bottom: 20-1/8" x 7-1/2"
- » Fits all air box styles listed on page 132
- » 000-5100A-B available & fits older style 51-series air boxes

| | | |
|----------------|-------------|------|
| Rounded Bottom | 000-5200A | \$55 |
| Square Bottom | 000-5100A-B | \$70 |

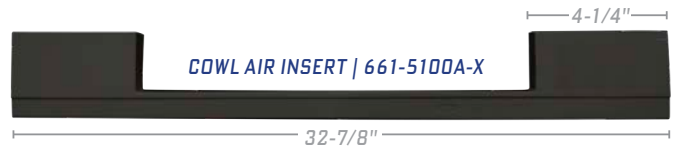

COWL AIR INSERT | 661-5100A-X

COWL AIR INSERT

- » Designed for maximum airflow directly into the cold air box
- » Made of Ultraglass composite & oversized for left & right adjustment to properly fit the airbox
- » Opening meets all sanctioning regulations
- » Included with ABC Body Packages
- » Available in 4 colors

| | | | |
|-----------------|-------------|------|------|
| Cowl Air Insert | 661-5100A-X | \$68 | \$73 |
|-----------------|-------------|------|------|

FITS THESE BODY STYLES: ABC NEXTGEN, ABC, NORTH AMERICAN SPORTSMAN, S2, STRAIGHT-UP METAL, SHORT TRACK TRUCK

ALUMINUM COWL BRACKET TABS

- » Create a positive seal by holding hood flat at the cowl
- » Mounts along front flange of Cowl Panel
- » Fits 3/8" or 1/2" Hood Pins
- » Kit is included with cowl panels
- » Kit includes: 4 laser-cut aluminum tabs weighing 0.5 oz each

| | | |
|-------------------|---------|------|
| Cowl Bracket Tabs | 000-510 | \$13 |
|-------------------|---------|------|



REAR BUMPERS

- » Formed using CNC progressive tube bending technology
- » Fits the exact contour of Five Star noses for maximum protection and ease of installation
- » Formed from 1-3/4" OD round steel tubing
- » For a complete secure mount, it is recommended to install your bumpers with Five Star's Rear Bumper Mounting Kits

| | | | | | |
|---|-------------|------|---|-----------|------|
| ABC NextGen, .065" steel | 11002-71682 | \$48 | Street Stock '88 Monte Carlo, .065" steel | 600-7501 | \$48 |
| NextGen LMSC, .065" steel | 11002-71682 | \$48 | Dirt Grand National, .065" steel | 570-7503 | \$48 |
| ABC / LMSC / Straight-Up Metal, .065" steel | 570-7503 | \$48 | Short Track Truck, .065" steel | T000-7503 | \$48 |
| North American Sportsman, .065" steel | 11002-71682 | \$48 | | | |

REAR BUMPER FULLY INSTALLED WITH HEIGHT ADJUSTABLE MOUNTING KIT
(HIGHLIGHTED IN ORANGE)

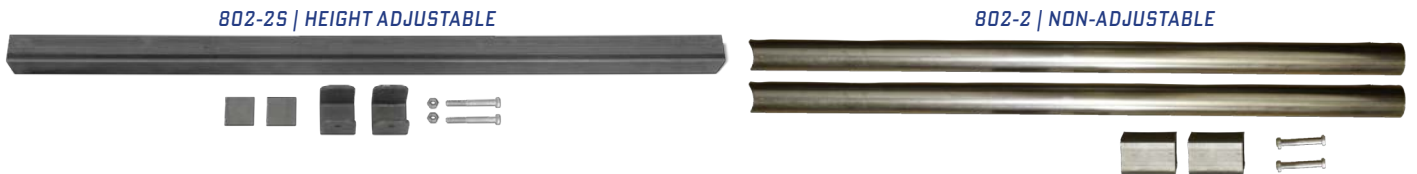
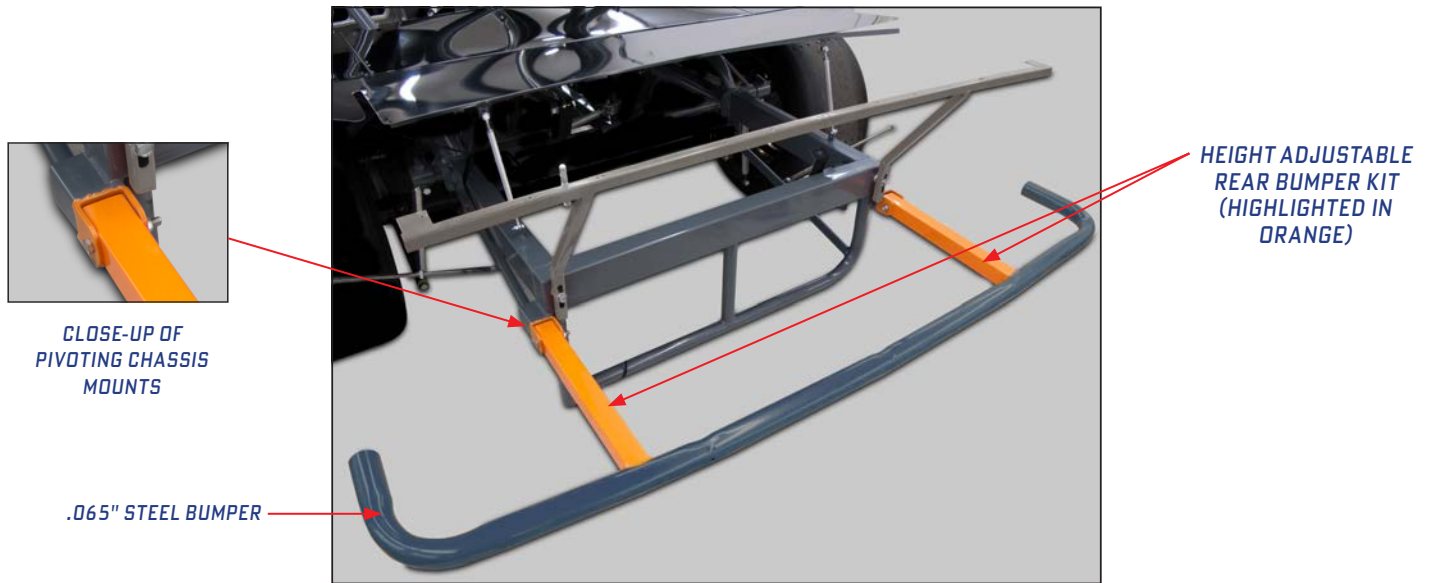

REAR BUMPER MOUNTING KITS

- » Everything you need to mount the bumper to the chassis
- » Universal design for all Five Star Short Track Noses
- » Fits all chassis configuration
- » Available in two options:
 - » **Height-Adjustable Kit:** (PN 802-2S) Allows for several different mounting options and pivots to allow precise adjustments to the height of the rear bumper cover
Kit includes: 2 pivoting chassis mounts; 1 36" long 1-1/2" square piece of tubing; 2 pieces of flat stock; 2 1/2" nuts and bolts
 - » **Non-Adjustable Kit:** (PN 802-2) Make your bumper a bolt-on component
Kit includes: 2 3' long x 1-3/4" thick pieces of round tubing, 2 pieces of .120" thick square tubing and 5/16" hex bolts & nuts

| | | |
|-----------------------|--------|------|
| Height-adjustable Kit | 802-2S | \$49 |
| Non-adjustable Kit | 802-2 | \$38 |

STEEL REAR DECK MOUNTING KIT

- » Everything you need to properly fabricate a perfect fitting brace from the rear bumper cover & deck lid to the chassis
- » **Deck Lid Bracket:** (PN 660-450-DLB) supports your rear body clip by securing it to the rear bumper cover & quarter panel.
Kit includes: 2 tabs for hood pins; weighs 36 oz
- » **Deck Lid Height Slider Kit:** (PN 802-3) allows for easy adjustment of spoiler height with 3-1/2" of deck lid height adjustability.
Kit includes: 2 pieces slotted 3/4" square tubing, 3/8" hex bolts & nuts
- » **Deck Lid Hold-down Kit:** (NOT SOLD SEPARATELY) allows for a removable deck lid.
Kit includes: 1 aluminum deck lid hold-down strip, 2 mounting tabs, 4 jam nuts, 2 3/8" gun-drilled, anodized aluminum pins & scuff plates (SILVER), & 2 flip-over steel clips

| | | |
|--|-------------|------|
| Rear Deck Mounting Kit | 660-450-RDK | \$87 |
| Replacement Deck Lid Bracket | 660-450-DLB | \$32 |
| Replacement Deck Lid Height Slider Kit | 802-3 | \$16 |

FITS THESE BODY STYLES: ABC NEXTGEN, ABC, NEXTGEN LMSC, LMSC, NORTH AMERICAN SPORTSMAN, S2, STRAIGHT-UP METAL, STREET STOCK, DIRT GRAND NATIONAL, MINI STOCK

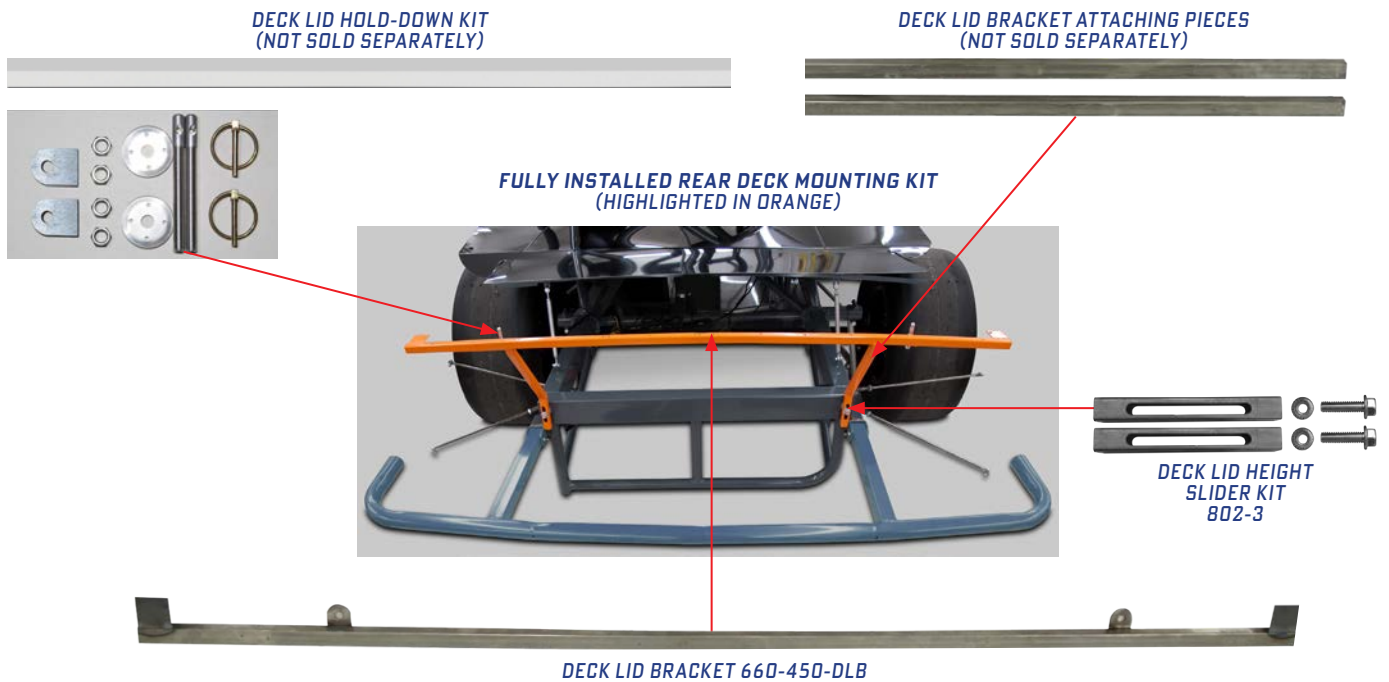

ONLY WEIGHS 17 OZ
LESS THAN HALF THE WEIGHT OF STEEL

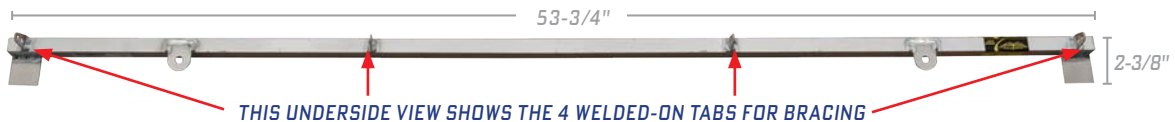

ALUMINUM DECK LID BRACKET

- » This is a premium upgrade from the steel deck lid bracket to save weight without sacrificing strength
- » Mounts to the rear bumper cover and quarter panel, includes 2 tabs for hood pins and 4 tabs for chassis mounting options
- » Complete the combination with our 3/8" Hood Pin Kit (PN 10001-34033-X)

| | | |
|---------------------------|-------------|------|
| Aluminum Deck Lid Bracket | 11002-75633 | \$49 |
|---------------------------|-------------|------|

FITS THESE BODY STYLES: ABC NEXTGEN, ABC, NEXTGEN LMSC, LMSC, NORTH AMERICAN SPORTSMAN, S2, STRAIGHT-UP METAL, STREET STOCK, DIRT GRAND NATIONAL, MINI STOCK



UNPAINTED BRACKETS WITH BLADES



BLACK POWDER-COATED BRACKETS WITH BLADES, FULLY INSTALLED USING 807-3 ADJUSTABLE BODY BRACES (SOLD SEPARATELY, SEE PG 141)

REPLACEMENT SPOILER BRACKETS & BLADES

- » 2-piece polycarbonate blade with 2-piece aluminum bracket, your choice of unpainted or black powder-coated
- » Available in 90, 70 and 55 degree angles

| ABC NextGen / NA Sportsman | 5" (90°) | 5" (70°) | 6-1/2" (90°) | 6-1/2" (70°) | | | |
|---|----------------|----------------|----------------|----------------|--------------|--------------|------|
| Brackets, replacement, aluminum, 60" | 11002-47369-1 | 11002-47367-1 | 11002-47369-1 | 11002-47367-1 | \$80 | | |
| Brackets, replacement, aluminum, 64-1/2" | N/A | N/A | 11002-47389-1 | 11002-47377-1 | \$80 | | |
| Brackets, replacement, aluminum, black, 60" | 11002-47369-1B | 11002-47367-1B | 11002-47369-1B | 11002-47367-1B | \$90 | | |
| Brackets, replacement, aluminum, black, 64-1/2" | N/A | N/A | 11002-47389-1B | 11002-47377-1B | \$90 | | |
| Blades, replacement, polycarbonate, 60" | 11002-47359-2 | 11002-47357-2 | 11002-47369-2 | 11002-47367-2 | \$49 | | |
| Blades, replacement, polycarbonate, 64-1/2" | N/A | N/A | 11002-47389-2 | 11002-47387-2 | \$59 | | |
| ABC / S2 / SU-Metal | 5" (90°) | 5" (70°) | 5" (55°) | 6-1/2" (90°) | 6-1/2" (70°) | 6-1/2" (55°) | |
| Brackets, aluminum | 661-6739-1 | 661-6737-1 | 661-6735-1 | 661-6739-1 | 661-6737-1 | 661-6735-1 | \$80 |
| Brackets, aluminum, black | 661-6739-1B | 661-6737-1B | 661-6735-1B | 661-6739-1B | 661-6737-1B | 661-6735-1B | \$90 |
| Blades, polycarbonate | 661-6749-2 | 661-6747-2 | 661-6745-2 | 661-6739-2 | 661-6737-2 | 661-6735-2 | \$49 |



SPOILER IS FULLY INSTALLED ON THE BUMPER COVER USING THE SPOILER MOUNTING KIT

ALUMINUM SPOILER MOUNTING KIT

- » Everything needed to mount the polycarbonate spoiler blade to the bracket, & the bracket to the bumper cover
- » 76-piece kit includes: 32 lightweight machined aluminum inner & outer washers, 22 flat head socket screws & 22 locknuts

| | | |
|----------------------|---------|------|
| Spoiler Mounting Kit | 000-67K | \$33 |
|----------------------|---------|------|





FULLY MOUNTED POLYCARBONATE RUB RAIL



POLYCARBONATE RUB RAIL

- » Protect your vinyl without hiding it!
- » Attach to side of body to eliminate tire marks on fenders, doors, and quarter panels
- » Ultra-durable polycarbonate to absorb impact
- » Can be trimmed to fit your application

| | | |
|--------------------|----------|---------|
| Rub Rail, 75" long | 000-2100 | \$21 ea |
|--------------------|----------|---------|



PLASTIC VERSION INCLUDES CURVED EDGE FOR OPTIMUM AERODYNAMICS



000-5501P-W
MOLDED PLASTIC STANDARD ROCKER PANEL

ALUMINUM VERSION HAS ENDS ROLLED BY SPECIAL PROCESS, ENHANCING AIR FLOW



000-5501A-W
ALUMINUM STANDARD ROCKER PANEL



000-5500A-W
ALUMINUM STRAIGHT ROCKER PANEL

EDGES ARE LEFT STRAIGHT, NOT CURVED

MOLDED PLASTIC & ALUMINUM ROCKER PANELS

- » Mounts below the fender / door / quarter panel area and fits either side
- » Curved edges provide optimum aerodynamics and adds structural integrity to side body panels
- » Manufactured in high-impact plastic and lightweight aluminum
- » Available in 5 color options

| | | | W-B | CB-R-Y |
|-------------------------------------|-------------|--------------|------|--------|
| High-Impact Plastic (N/A IN YELLOW) | 000-5501P-x | 82" x 5" | \$33 | \$38 |
| Aluminum | 000-5501A-x | 77-3/4" x 5" | \$39 | \$39 |
| Aluminum, straight | 000-5500A-x | 79" x 4-3/4" | \$39 | n/a |

FITS THESE BODY STYLES: ABC NEXTGEN, ABC, NEXTGEN LMSC, LMSC, NORTH AMERICAN SPORTSMAN, S2 SPORTSMAN, SHORT TRACK TRUCK, STREET STOCK



FULLY INSTALLED WINDOW BRACE KIT

WEIGHS LESS THAN 2 LBS



ALUMINUM WINDOW BRACES

- » Strongest window braces on the market
- » Designed to the exact contour of your Five Star windows
- » Made of premium high-strength aluminum with flat black powder-coated finish
- » Foam-padded surface won't scratch your windows
- » Pre-drilled holes to mount adjustable bracing from the interior dash
- » **Kit includes:** 3 aluminum braces & installation hardware

| Windshield Brace Kits | | C=Center, L=Left, R=Right, O=outer, all 1" Wide | |
|--|-------------|---|------|
| ABC Next Gen Windshield Brace Kit | 11002-76333 | 24-1/8"(C), 24-1/4"(L), 24-1/2"(R) | \$76 |
| NextGen Late Model Stock Car Windshield Brace Kit | 13002-76333 | 25-5/8"(C), 25-1/2"(L), 25-5/8"(R) | \$76 |
| ABC/LMSC/Straight-Up Metal Windshield Brace Kit | 564-6301 | 28-5/8" x 1" | \$76 |
| North American Sportsman Windshield Brace Kit | 12001-76333 | 26" x 1" | \$76 |
| Pavement Modified Windshield Brace Kit | 020-6301 | 26-1/2" x 1" | \$76 |
| Short Track Truck Windshield Brace Kit | 21001-76333 | 31-5/8"(C), 31-3/4"(L), 31-1/2"(R) | \$76 |
| Rear Window Brace Kits | | C=Center, L=Left, R=Right, O=outer, all 1" Wide | |
| ABC NextGen Rear Window Brace Kit | 11002-76133 | 30-7/8"(C), 30-5/8"(O) | \$76 |
| NextGen Late Model Stock Car Rear Window Brace Kit | 11002-76133 | 30-7/8"(C), 30-5/8" (O) | \$76 |
| ABC/LMSC/Straight-Up Metal Rear Window Brace Kit | 674-6101 | 32" x 1" | \$76 |
| North American Sportsman Rear Window Brace Kit | 12001-76133 | 31-1/4"(C), 30-1/2"(O) | \$76 |
| Pavement Modified Rear Window Brace Kit | 020-6101 | 34" x 1" | \$76 |



IMPORTANT:
 USING RIVETS APPLIES TOO MUCH PRESSURE TO YOUR WINDOW & WILL FRACTURE THE POLYCARBONATE



WINDOW INSTALLATION KIT

- » Using proper hardware provides the perfect fit & helps to increase the life of your window
- » Black oxide coated to prevent rust
- » Enough hardware to install a complete set of windows on one car
- » **Kit includes:** 120 6-32 1/2" & 16 6-32 3/4" flat head socket screws, 136 6-32 nylon locknuts, 1 long-arm hex key & 9/64" drill bit

| | | |
|-------------------------|-----|------|
| Window Installation Kit | 805 | \$23 |
|-------------------------|-----|------|

WINDOW INSTALLATION COUNTERSINK DRILL BIT

- » 3/8" diameter steel bit, 1/4" shank, used for countersinking holes for window screw installation into polycarbonate
- » Not required for pre-cut to fit, beveled, & drilled windows

| | | |
|-----------|-------|------|
| Drill Bit | 805-1 | \$19 |
|-----------|-------|------|

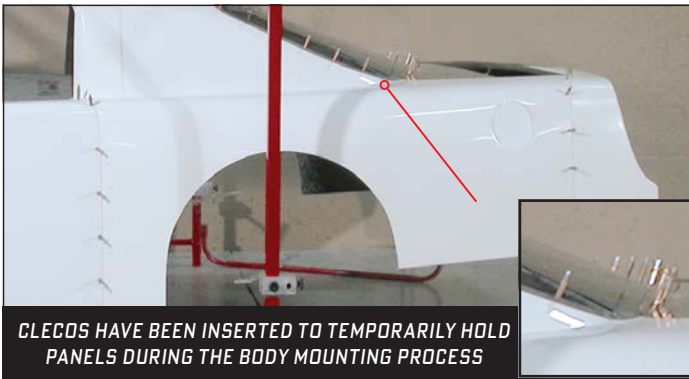

CLECOS HAVE BEEN INSERTED TO TEMPORARILY HOLD PANELS DURING THE BODY MOUNTING PROCESS

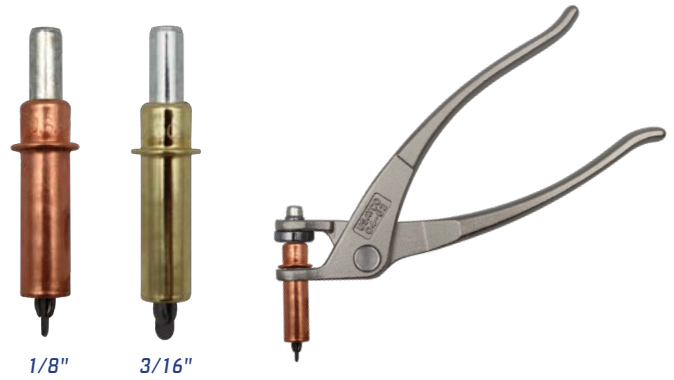

CLECO KIT & PLIERS

- » Precision has never been this easy! Cleco Pliers & Cleco Fasteners ensure perfect alignment every time
- » Clecos can be easily inserted with the Cleco Pliers to temporarily hold panels during the body mounting process
- » Our Cleco pliers are engineered for comfort & built to last, ensuring a secure grip & maximum control
- » Choice of 1/8" 25-piece Cleco Kit or 3/16" 25-piece Cleco Kit

| | | |
|------------------------------|-----|------|
| 1/8" Single Spade Kit, long | 812 | \$24 |
| 3/16" Single Spade Kit, long | 813 | \$32 |
| Cleco Pliers | 811 | \$12 |

RIGHT SIDE DOOR SUPPORT

- » Easily adjust your right side door to the proper width
- » This piece connects your right side door bar to your door
- » .080" thick aluminum laser-cut to reduce weight
- » Laser cutting allows for precise, consistent shape & weight
- » Slotted mounting holes allow for easy inner & outer door adjustments to proper width
- » Weighs under 2 lbs

| | | |
|-----------------------|-------------|------|
| Aluminum Door Support | 11002-75533 | \$30 |
|-----------------------|-------------|------|



FULLY INSTALLED 11002-75533



DETAILS AND



DIMENSIONS

DRILL BIT KIT

- » Special double-ended drill bits
- » These bits drill a slightly larger diameter hole than a standard 1/8" or 3/16" bit to prevent stress cracks in the material
- » The short drill shaft makes drilling in tight places easier
- » Kit includes: 2 9/64" double-ended drill bits & 2 #30 double-ended drill bits

| | | |
|---------------|-----|------|
| Drill Bit Kit | 806 | \$18 |
|---------------|-----|------|



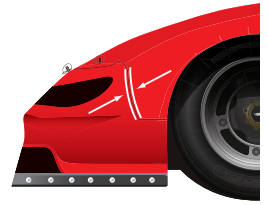
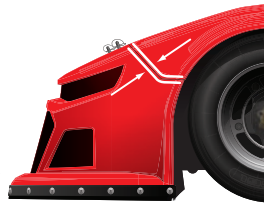
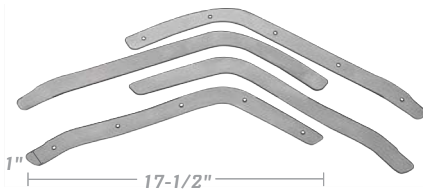

11002-75133

FOR ABC NEXTGEN, 2020 LATE MODEL STOCK CAR, NORTH AMERICAN SPORTSMAN

000-24B

FOR ABC, LMSC, S2, STRAIGHT-UP METAL, DIRT GRAND NATIONAL

FENDER-TO-NOSE BACK-UP PLATES KIT

- » Reinforces the flange where the fenders mount to the nose
- » Pre-drilled holes in the necessary locations for quick & easy mounting
- » Made of .063" thick aluminum
- » **4-piece kits include: 2 front & 2 rear plates** (ENOUGH FOR BOTH SIDES)

| | | |
|---|-------------|------|
| ABC NextGen / NextGen LMSC / NA Sportsman | 11002-75133 | \$20 |
| Other Body Styles* | 000-24B | \$21 |

*FITS THESE BODY STYLES: ABC, LMSC, S2, STRAIGHT-UP METAL, DIRT GRAND NATIONAL

GREENHOUSE-TO-QUARTER PANEL BACK-UP PLATES KIT

- » Reinforce the flanges where the rear greenhouse meets the quarter panels
- » Universal fit for all greenhouse-style quarter panels
- » Each back-up plate is 60 X 1-12"
- » Recommended for molded plastic quarter panels
- » **Kit includes: 2 pre-cut aluminum strips**

| | | |
|-------------|---------|-----|
| 2-piece Kit | 000-27B | \$7 |
|-------------|---------|-----|

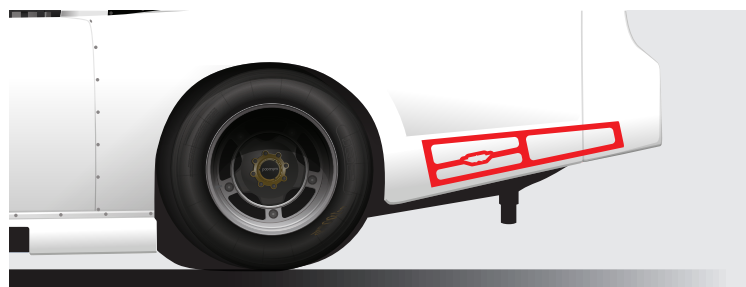
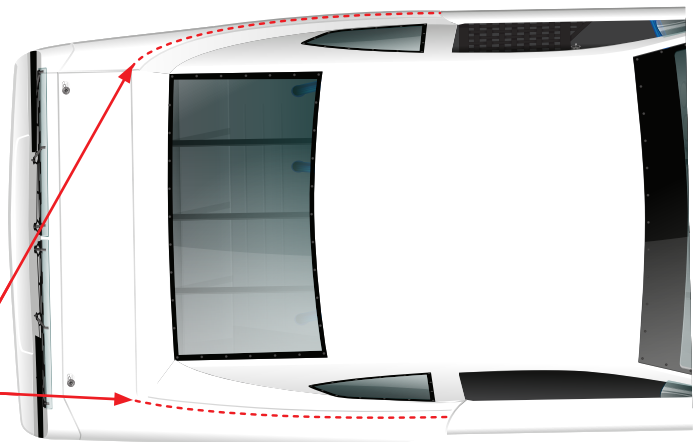

WEIGHS ONLY 1 LB

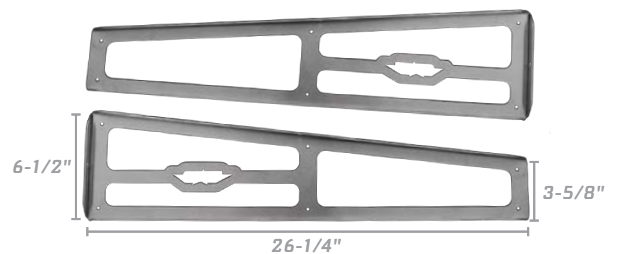

QUARTER PANEL BODY BRACE KIT

- » Stiffens the quarter panel to maintain correct shape in an aero sensitive area
- » Highly recommend bracing for tracks 1/2-mile & longer
- » Laser-cut aluminum braces have pre-drilled holes for brace attachment
- » **Kit includes: 2 braces that mount approximately 6" back from the wheel opening & 2" up from the bottom ledge**

| | | |
|--------------------|-------------|------|
| Brace Kit, 2-piece | 11002-75433 | \$39 |
|--------------------|-------------|------|



EASY INSTALLATION WITH ENDS SHAPED FOR INCLUDED SCREW KIT OR 2 RIVETS



ADJUSTABLE BODY BRACES

- » Used for spoiler & roof supports & anywhere on your car to fit templates & meet other critical dimensions
- » Easy installation with ends shaped for included screw kit or 2 rivets
- » Adjustable from 8" to 10-1/2" & features durable anodized black finish & zinc-plated hardware
- » Add extra support without adding excess weight! Package of 2 weighs only 1/2 lb
- » Can also be attached to Five Star's Chassis Clamps for quick & easy adjustable bracing on your chassis

| | | |
|---------------------|-------|------|
| Body Braces, 2 pack | 807-3 | \$35 |
|---------------------|-------|------|

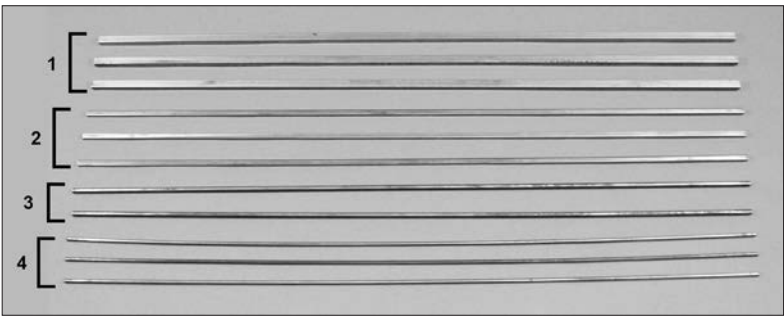

| Number | Shape | Dia | Thickness | Length |
|--------|------------|------|-----------|--------|
| 1 | (3) round | 3/8" | .062" | 60" |
| 2 | (3) square | 1/2" | .035" | 60" |
| 3 | (2) round | 1/2" | .062" | 60" |
| 4 | (3) square | 3/4" | .049" | 60" |

STEEL TUBING INSTALLATION KIT

- » 55 feet of .035" hard-to-find, lightweight steel tubing for any miscellaneous needs on a race car
- » Will save at least 12 lbs over standard .065" steel tubing
- » Kit includes various shapes and sizes in 60" lengths

| | | |
|---------------------|-----|------|
| 11-pcs: 60" lengths | 819 | \$79 |
|---------------------|-----|------|



FORMED POLYCARBONATE BODY BRACES

- » Universal brace to fit any applicable area of your car
- » Each lightweight brace weighs only 7 oz
- » Absorbs impact & allows body panels to flex upon impact & return to original position & shape
- » Kit includes: 7 clear polycarbonate braces & 14 1"x2" aluminum mounting tabs

| | | |
|----------------------|-----|------|
| Polycarbonate Braces | 804 | \$30 |
|----------------------|-----|------|

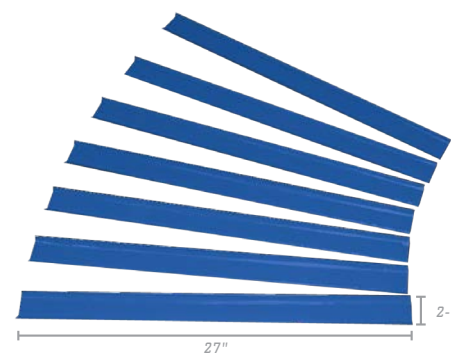

BRACES ARE SHOWN WITH PROTECTIVE MASKING



FULLY INSTALLED CUSTOM BRACE KIT



TAP | 807L OR 807R



THREADED END ASSEMBLIES | 807-2



ALUMINUM TUBING | 807-1

ALUMINUM CUSTOM BRACING KIT

- » Build your own custom-length bracing as short as 6" or as long as 40"
- » Order as many tubing kits or end assemblies as needed to custom brace your car
- » Threaded end assemblies can be bolted, riveted, or attached with hose clamps
- » **Complete kit includes:** 1 aluminum tubing kit; 1 threaded end assembly kit; 1 left & 1 right 1/4-20 reusable tap
- » **Aluminum Tubing kit includes:** 2 7/16" x 3' hollow hex rods. Cut to desired length & can be tapped easily
- » **Threaded End Assemblies kit includes:** 2 right and 2 left threaded ends, 2 hose clamps that weighs 7.5 oz

| | | |
|--------------------------|---------|------|
| Complete Kit | 807 | \$68 |
| REPLACEMENT PARTS | | |
| Tubing Kit, 2-piece | 807-1 | \$29 |
| End Assemblies, 6-piece | 807-2 | \$19 |
| Tap, left or right | 807LorR | \$10 |



CLOSE UP OF FULLY INSTALLED TAB



STEEL BODY MOUNTING TABS

- » Designed to be welded onto chassis as a universal mount for many applications
- » Makes mounting easier by positioning bracing and mounts right where you need them
- » 25-piece kit includes enough lightweight weld-on tabs to install a complete body & weighs 5 oz
- » Each tab is 1-1/8" x 1-2"
- » Use for roof, cowl, deck lid, side bracing, and more

| | | |
|--------------|-------|------|
| 25 Piece Kit | 807-4 | \$24 |
|--------------|-------|------|



TWO BRACES CAN BE MOUNTED & BRANCHED OFF A SINGLE MOUNTING END

THUMB SCREW FOR QUICK, EASY ADJUSTMENT TO MEET CRITICAL DIMENSIONS

TWO BRACES CAN ALSO BE MOUNTED TO A FIVE STAR CHASSIS CLAMP

STAMPED ALUMINUM MOUNTING END CLOSE-UP

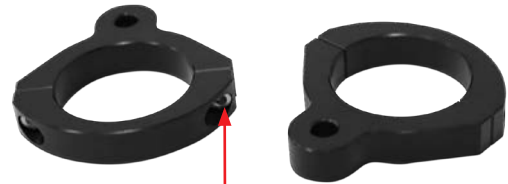

INCLUDES TWO SCREWS FOR QUICK, EASY INSTALLATION & ADJUSTMENT WITH 3MM ALLEN WRENCH

» NYLON (MOST FLEXIBLE) WEIGHS 5 OZ EA

» ALUMINUM (LIGHTEST) WEIGHS 3.25 OZ EA

» STEEL (MOST DURABLE) WEIGHS 8.25 OZ EA

PREMIUM ADJUSTABLE BODY BRACE KITS

- » Available in three options: aluminum, nylon, or steel
- » Adjustable to a maximum length of 30-1/2"
- » Stamped, black anodized aluminum mounting ends
- » Thumb screw for quick, easy length adjustments without tools
- » Kits come complete in a pack of 2

| | | |
|--------------------------|-------------|------|
| Flexible Nylon Brace Kit | 10001-75951 | \$33 |
| Aluminum Brace Kit | 10001-75933 | \$30 |
| Steel Brace Kit | 10001-75931 | \$21 |

ALUMINUM CHASSIS CLAMPS

- » Universal mount fits anywhere bracing is needed
- » Eliminate the need for welding or use of hose clamps when mounting body braces
- » Threaded flange / no nut required
- » Three options to fit different roll bar tubing thickness
- » Lightweight black anodized aluminum, each clamp weighs just 1.3 oz
- » Ideal for use with Five Star's Premium Adjustable Body Braces
- » Kits include: 2 clamps with 1/4-20 screws

| | | |
|--------------------------|-------------|------|
| 1-1/2", aluminum, 2 pack | 10001-74133 | \$21 |
| 1-3/4", aluminum, 2 pack | 10001-74333 | \$21 |
| 1-5/8", aluminum, 2 pack | 10001-74533 | \$21 |



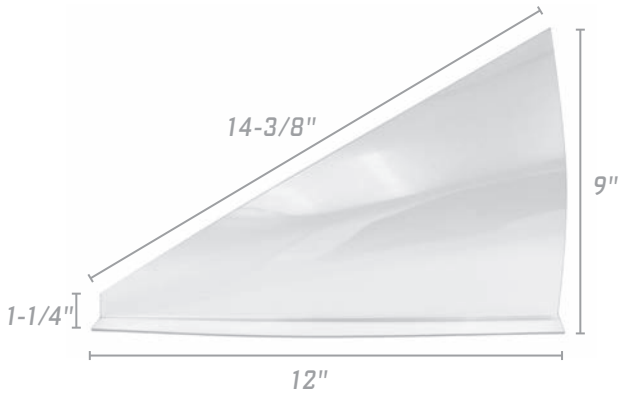

THE 11002-66222 DOOR VENT WINDOW IS CUT-TO-FIT FOR FAST & EASY INSTALLATION

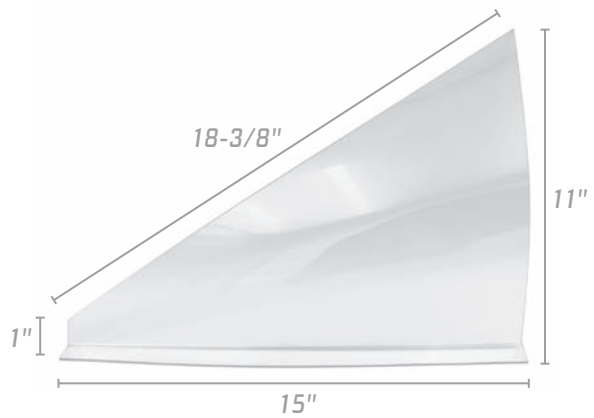

THE 000-6202 DOOR VENT WINDOW IS OVERSIZED; TRIM TO FIT YOUR APPLICATION



POLYCARBONATE DOOR VENT WINDOWS

- » Molded vent windows give cars a proven performance gain in the wind tunnel over flat unmolded windows
- » Oversized and cut-to-fit options made of molded, mar-resistant coated clear .093" polycarbonate

| | | |
|--|-------------|------|
| Precut-to-fit, set of 2 | 11002-66222 | \$33 |
| <i>FITS THESE BODY STYLES: ABC NEXTGEN, NEXTGEN LMSC</i> | | |
| Universal, set of 2 | 000-6202 | \$35 |

WIDE ANGLE RACING MIRROR

- » This convex glass mirror gives you the best view of your competition, includes a bracket kit for easy installation
- » All black frame with black anodized machined aluminum brackets
- » Only weighs 19 oz

| | | |
|---------------------|-------------|------|
| Convex Glass Mirror | 00001-85020 | \$39 |
|---------------------|-------------|------|



UNIVERSAL MIRROR MOUNTING BRACKET

- » This stamped lightweight aluminum bracket allows for easy installation on any chassis
- » Satin black powder coated finish

| | | |
|---------------------|-------|-----|
| Replacement Bracket | 820-B | \$9 |
|---------------------|-------|-----|



THE PERFECT SURFACE PREP FOR PLASTIC

MD3 ADHESION PROMOTER

NEW!



FAST DRYING & NON-SANDING



MD3 ADHESION PROMOTER

- » Specifically engineered adhesion promoter assures proper paint bonding to our special plastic
- » Other automotive grade primers on the market may not work at all or cause severe paint flaking
- » Improves adhesion of vinyl by enhancing the bond between adhesive on the vinyl and the substrate, for a more durable, long-lasting application
- » Comes in an aerosol spray can for quick and easy application
- » A single can coats approximately 5 individual parts

| | | |
|-----------------------|-----|------|
| MD3 Adhesion Promoter | 842 | \$16 |
|-----------------------|-----|------|

» A MUST USE PRODUCT BEFORE PAINTING OR APPLYING VINYL ON ANY FIVE STAR PLASTIC PART

FIVE STAR PLASTIC WINDOW CLEANER

- » This specially formulated anti-static foaming spray contains no chemicals or abrasives that will cause damage to plastic
- » Lifts grease, grime, and wipes off fast and easy to provide a streak-free clean and clear surface finish

| | | |
|--------------------------|-----|--------|
| Window Cleaner, 19oz Can | 843 | \$9.95 |
|--------------------------|-----|--------|

» FIVE STAR CLEANING TIPS!

- » ALWAYS AVOID USING ABRASIVE CLEANERS & CHEMICAL SOLVENTS THAT CAN EASILY CAUSE DAMAGE TO POLYCARBONATE WINDOWS
- » USE A MICROFIBER TOWEL FOR BEST, STREAK-FREE FINISH
- » TO PREVENT SCRATCHING AND HAZING ON YOUR WINDOWS, NEVER SCRUB WITH BRUSHES OR ABRASIVE MATERIALS



PRICING SUBJECT TO CHANGE WITHOUT NOTICE

UNIVERSAL SHORT TRACK

NOSES, BUMPER COVERS & COMPONENTS

VINYL NOSE GRAPHIC ID KITS FOR A REALISTIC OEM LOOK!

PRINTED ON OUTDOOR DURABLE HIGH-TACK VINYL • GLOSSY LAMINATED SURFACE PROVIDES EXCELLENT PROTECTION



'97 CHEVROLET CAMARO

-W

| | | |
|------|-----------|-------|
| Nose | 150-410-W | \$178 |
|------|-----------|-------|

*NOSE GRAPHIC ID KITS NO LONGER AVAILABLE

'97 CHEVROLET CAMARO

-W

| | | |
|--------------|-----------|-------|
| Bumper Cover | 150-450-W | \$160 |
|--------------|-----------|-------|

*BUMPER COVER GRAPHIC ID KITS NO LONGER AVAILABLE



'92 CHEVROLET CAMARO

-B -W

| | | |
|-----------------|-----------|-------|
| Nose (PAVEMENT) | 140-410-x | \$178 |
|-----------------|-----------|-------|

| | | |
|-------------|------------|------|
| Nose ID Kit | 140-410-ID | \$37 |
|-------------|------------|------|



'92 CHEVROLET CAMARO

-B -W

| | | |
|------|-----------|-------|
| Nose | 145-410-x | \$178 |
|------|-----------|-------|

| | | |
|-------------|------------|------|
| Nose ID Kit | 140-410-ID | \$37 |
|-------------|------------|------|



'81 CHEVROLET CAMARO

-B

| | | |
|-------------|------------|------|
| Nose, Upper | 210-410U-B | \$80 |
|-------------|------------|------|

*NOSE GRAPHIC ID KITS NO LONGER AVAILABLE



'81 CHEVROLET CAMARO

-B

| | | |
|-------------|------------|------|
| Nose, Lower | 210-410L-B | \$75 |
|-------------|------------|------|

*NOSE GRAPHIC ID KITS NO LONGER AVAILABLE



'03 CHEVROLET MONTE CARLO

-B -W

| | | |
|---------------------|------------|-------|
| Nose (FG SPORTSMAN) | 639-410-x | \$178 |
| Nose (SHORT TRACK) | 640-410-x | \$178 |
| Nose ID Kit | 630-410-ID | \$37 |



'03 CHEVROLET MONTE CARLO

-B -W

| | | |
|---------------------|------------|-------|
| Bumper Cover | 630-450-x | \$160 |
| Bumper Cover ID Kit | 630-450-ID | \$36 |



'99 CHEVROLET MONTE CARLO

-B -W

| | | |
|-------------|------------|-------|
| Nose | 620-410-x | \$178 |
| Nose ID Kit | 620-410-ID | \$37 |

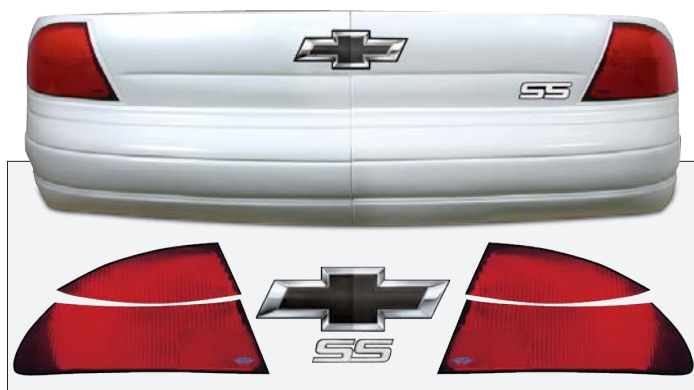

'99 CHEVROLET MONTE CARLO

-B -W

| | | |
|---------------------|------------|-------|
| Bumper Cover | 620-450-x | \$160 |
| Bumper Cover ID Kit | 620-450-ID | \$36 |



'94 CHEVROLET LUMINA

-W

| | | |
|------|-----------|-------|
| Nose | 610-410-W | \$178 |
|------|-----------|-------|

*NOSE GRAPHIC ID KITS NO LONGER AVAILABLE



'94 CHEVROLET LUMINA

-W

| | | |
|--------------|-----------|-------|
| Bumper Cover | 610-450-W | \$160 |
|--------------|-----------|-------|

*BUMPER COVER GRAPHIC ID KITS NO LONGER AVAILABLE



'03 FORD TAURUS

-B -W

| | | |
|-------------|------------|-------|
| Nose | 550-410-x | \$178 |
| Nose ID Kit | 550-410-ID | \$37 |



'03 FORD TAURUS

-B -W

| | | |
|--------------|-----------|-------|
| Bumper Cover | 550-450-x | \$160 |
|--------------|-----------|-------|

**BUMPER COVER GRAPHIC ID KITS NO LONGER AVAILABLE*



'97 FORD THUNDERBIRD

-W

| | | |
|------|-----------|-------|
| Nose | 530-410-W | \$178 |
|------|-----------|-------|

**NOSE GRAPHIC ID KITS NO LONGER AVAILABLE*



'97 FORD THUNDERBIRD

-W

| | | |
|--------------|-----------|-------|
| Bumper Cover | 530-450-W | \$160 |
|--------------|-----------|-------|

**BUMPER COVER GRAPHIC ID KITS NO LONGER AVAILABLE*



PONTIAC GRAND PRIX

-B -W

| | | |
|-------------|------------|-------|
| Nose | 360-410-x | \$164 |
| Nose ID Kit | 360-410-ID | \$37 |

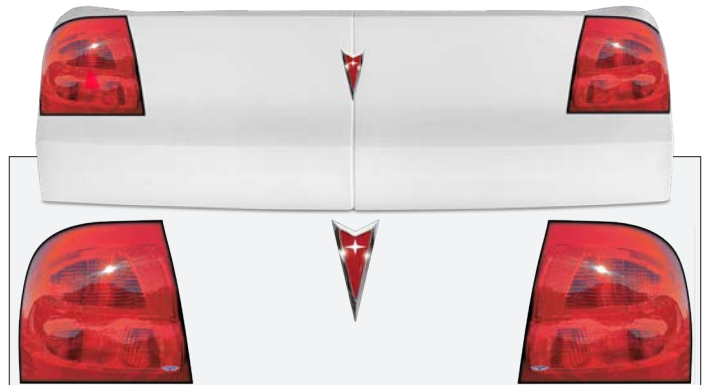

PONTIAC GRAND PRIX

-B -W

-CB -R

| | | | |
|---------------------|------------|-------|-------|
| Bumper Cover | 460-450-x | \$155 | \$160 |
| Bumper Cover ID Kit | 360-450-ID | \$36 | \$36 |



'97 OLDSMOBILE CUTLASS

-W

| | | |
|-------------|------------|-------|
| Nose | 710-410-x | \$178 |
| Nose ID Kit | 710-410-ID | \$37 |



H00-410S: Round, small \$8



H01-410S: Rectangle, small \$8



H00-411S: Round, large \$8



H01-411S: Rectangle, large \$8

NEW!

ACHIEVE MAXIMUM VINYL ADHESION BY USING MD3 ADHESION PROMOTER. DETAILS AND ORDERING INFORMATION ON PAGE 147!



» ALUMINUM NOSE SCREENS: PROTECT YOUR RADIATOR FROM DEBRIS PENETRATION

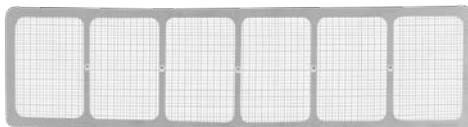

UNPAINTED

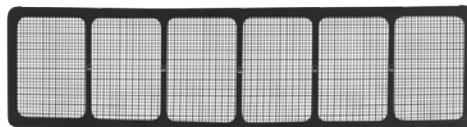

BLACK POWDER-COATED

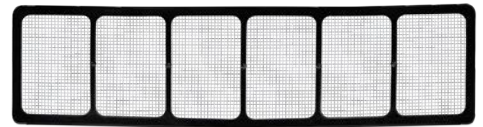

BLACK ALUMINUM FRAME

ALUMINUM NOSE SCREENS

- » Protects the radiator from debris penetration
- » Frame is laser cut from lightweight aluminum
- » Screen is high strength stainless steel (3/16" mesh is crimped, 1/4" is welded)
- » Available options: black aluminum frame, unpainted, or with durable satin black powder-coated finish

| PN | NOSE SCREEN DESCRIPTION | WIDTH (Top) | WIDTH (Bottom) | HEIGHT | MESH | |
|--------------|-------------------------------------|-------------|----------------|--------|-------|------|
| 630-4111 | O1 Monte Carlo, Lower | 34" | 34" | 6" | 3/16" | \$50 |
| 660-4111 | Common*, Lower | 27-3/4" | 27-3/4" | 7-1/4" | 3/16" | \$50 |
| 660-4111-B | Common, Lower, Black | 27-3/4" | 27-3/4" | 7-1/4" | 3/16" | \$55 |
| 660-4112 | Common, Lower | 27-3/4" | 27-3/4" | 7-1/4" | 1/4" | \$50 |
| 660-4112-B | Common, Lower, Black | 27-3/4" | 27-3/4" | 7-1/4" | 1/4" | \$55 |
| 10001-46333B | Common, Lower, Black aluminum frame | 27-3/4" | 27-3/4" | 7-1/4" | 3/16" | \$55 |
| 10001-46433B | Common, Lower, Black aluminum frame | 27-3/4" | 27-3/4" | 7-1/4" | 1/4" | \$55 |

*COMMON NOSE SCREEN FITS THESE BODY STYLES: ABC NEXTGEN, ABC, NEXTGEN LATE MODEL STOCK CAR, LATE MODEL STOCK CAR, NORTH AMERICAN SPORTSMAN, STRAIGHT-UP METAL, MD3 CAMARO/MUSTANG STREET STOCK, DIRT GRAND NATIONAL

PRICING SUBJECT TO CHANGE WITHOUT NOTICE

ABC LMSC TRUCK RAY MODIFIED OUTLAW LATE MODEL SPORTSMAN STREET STOCK MD3 LATE MODEL MD3 MODIFIED DIRT GRAND NAT'L TAZ PRO STOCK/MOD FUNNY CAR WINDOWS ACCESSORIES